



PART No. 1418N4S16LL12

for more information visit

www.hammfg.com

Data subject to change without notice

Isometric drawing Not to Scale

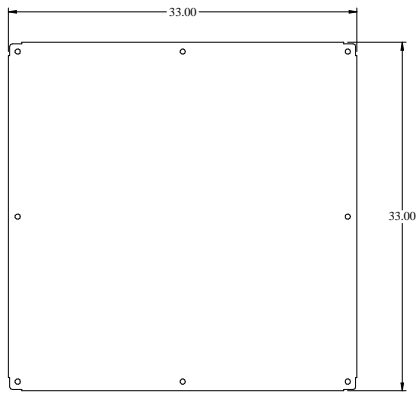

INNER PANEL

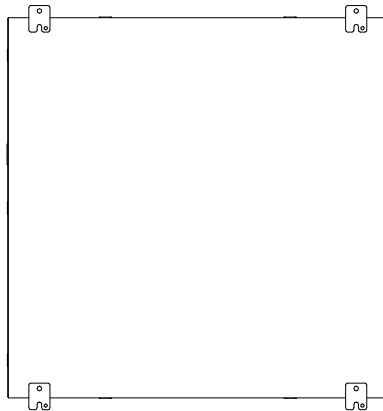

BACK VIEW

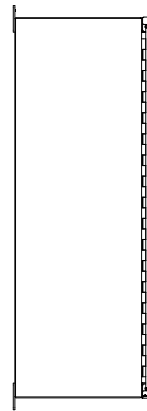

SIDE VIEW

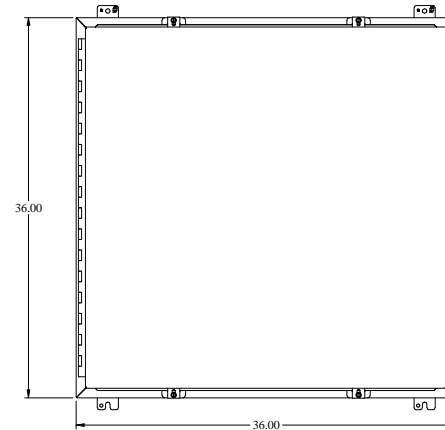

FRONT VIEW

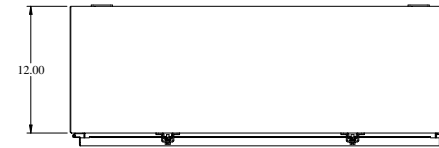

TOP VIEW

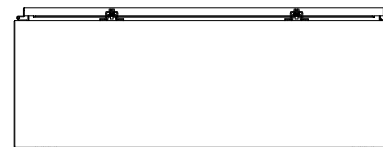

BOTTOM VIEW

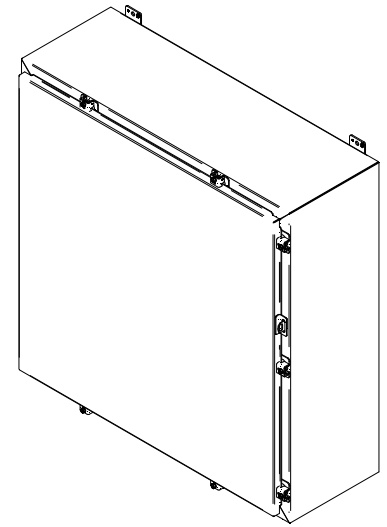

ISOMETRIC VIEW

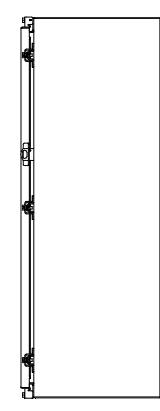

SIDE VIEW