

PROCESS CPD83V
Switching Diode
High Speed Switching Diode Chip



PROCESS DETAILS

Process	EPITAXIAL PLANAR
Die Size	11 x 11 MILS
Die Thickness	7.1 MILS
Anode Bonding Pad Area	3.35 x 3.35 MILS
Top Side Metalization	Al - 30,000Å
Back Side Metalization	Au-As - 13,000Å

GEOMETRY

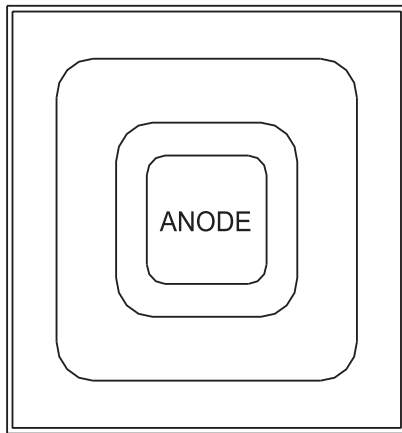

BACKSIDE CATHODE R0

GROSS DIE PER 5 INCH WAFER

137,880

PRINCIPAL DEVICE TYPES

- CMPD914
- CMPD4448
- 1N914
- 1N914B
- 1N4148
- 1N4448
- 1N4154
- 1N4454
- CMPD2836
- CMPD2838
- CMPD7000

R5 (22-March 2010)

PROCESS CPD83V

Typical Electrical Characteristics

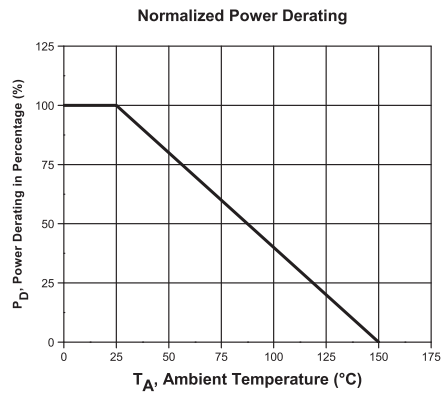
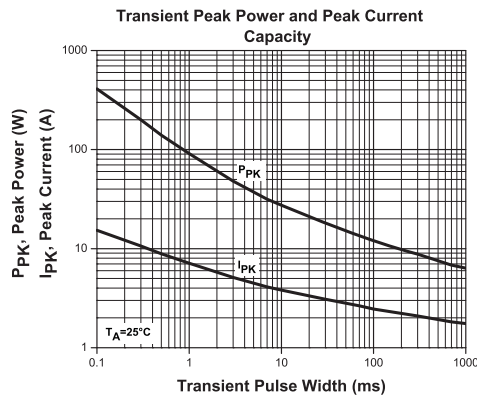
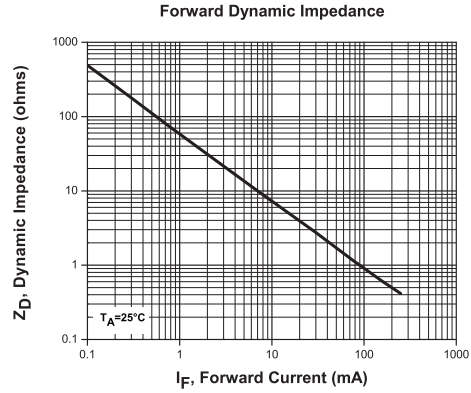
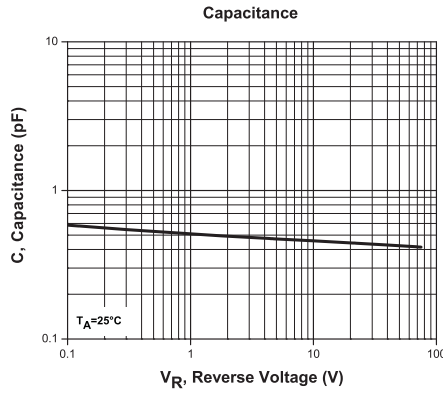
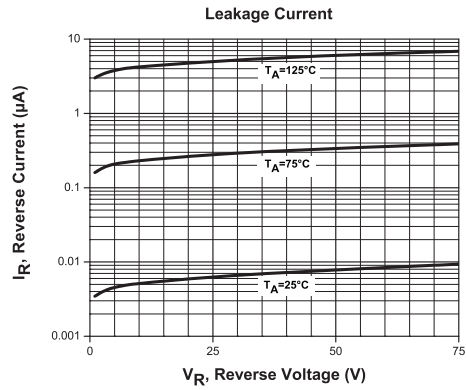
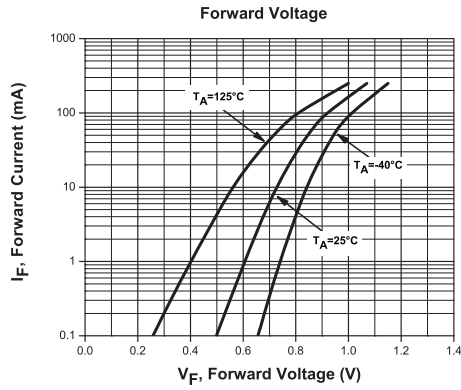

R5 (22-March 2010)

OUTSTANDING SUPPORT AND SUPERIOR SERVICES



PRODUCT SUPPORT

Central's operations team provides the highest level of support to insure product is delivered on-time.

- Supply management (Customer portals)
- Inventory bonding
- Consolidated shipping options
- Custom bar coding for shipments
- Custom product packing

DESIGNER SUPPORT/SERVICES

Central's applications engineering team is ready to discuss your design challenges. Just ask.

- Free quick ship samples (2nd day air)
- Online technical data and parametric search
- SPICE models
- Custom electrical curves
- Environmental regulation compliance
- Customer specific screening
- Up-screening capabilities
- Special wafer diffusions
- PbSn plating options
- Package details
- Application notes
- Application and design sample kits
- Custom product and package development

REQUESTING PRODUCT PLATING

1. If requesting Tin/Lead plated devices, add the suffix " TIN/LEAD" to the part number when ordering (example: 2N2222A TIN/LEAD).
2. If requesting Lead (Pb) Free plated devices, add the suffix " PBFREE" to the part number when ordering (example: 2N2222A PBFREE).

CONTACT US

Corporate Headquarters & Customer Support Team

Central Semiconductor Corp.
145 Adams Avenue
Hauppauge, NY 11788 USA
Main Tel: (631) 435-1110
Main Fax: (631) 435-1824
Support Team Fax: (631) 435-3388
www.centrasemi.com

Worldwide Field Representatives:
www.centrasemi.com/wwreps

Worldwide Distributors:
www.centrasemi.com/wwdistributors

For the latest version of Central Semiconductor's **LIMITATIONS AND DAMAGES DISCLAIMER**, which is part of Central's Standard Terms and Conditions of sale, visit: www.centrasemi.com/terms