

THIS DOCUMENT IS SUBJECT TO CHANGE WITHOUT NOTICE. IT IS CONFIDENTIAL AND A PROPERTY OF Amphenol LTW. DISCLOSURE TO THIRD PARTY HAS TO BE AUTHORIZED BY Amphenol LTW.

REV.	ECN NO.	DATE	SIGN	DESCRIPTION
B	LEN14C0417	2014/12/10	Vicky	Update Logo & Dimension

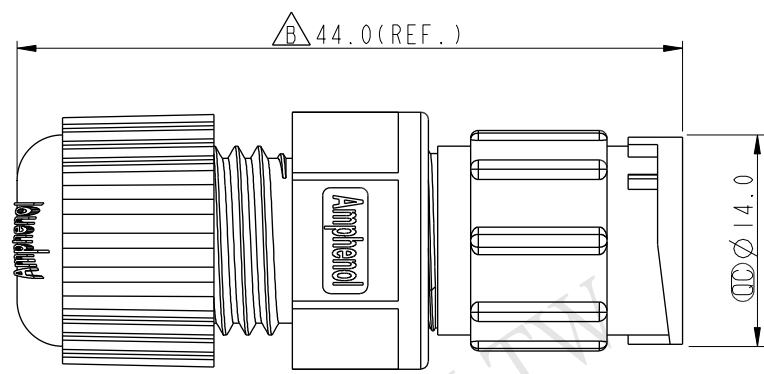
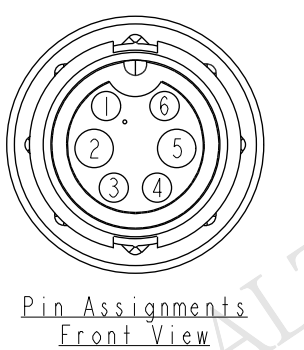
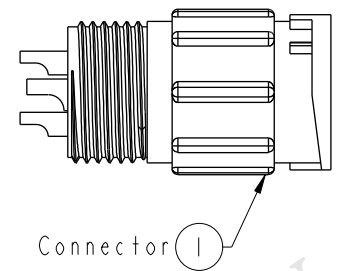
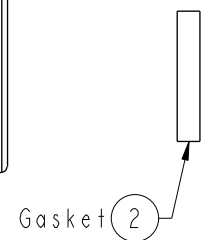
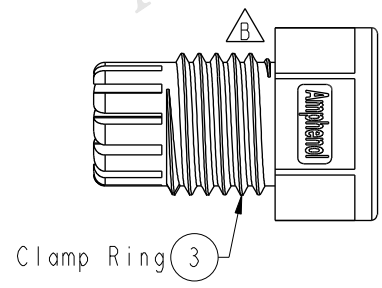
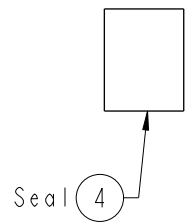
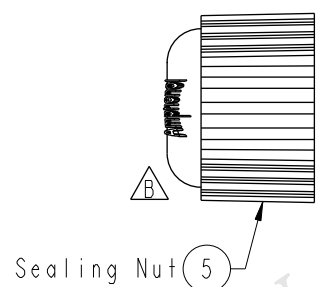
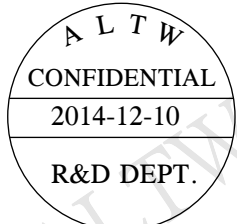

- Note:
- * CC Important Dimension To Check.
 - * Waterproof Rate: IP67
 - * Housing: Nylon+GF, Black
 - * Female Pin: Copper Alloy, Gold Plated
 - * Gasket: EPDM, Black
 - * Clamp Ring: Nylon, Black
 - * Seal: EPDM, Black
 - * Sealing Nut: Nylon, Black
 - * Seal For Cable OD: $\varnothing 4.5\text{mm} \sim \varnothing 6.5\text{mm}$
(防水墊圈線徑: $\varnothing 4.5\text{mm} \sim \varnothing 6.5\text{mm}$)
 - * One Set Unassembled In One PE Bag
(每一組未組裝, 放置於一個PE袋, 並封口)

UNIT:mm		
TOLERANCE		
.X	± 0.25	
.XX	± 0.1	
.XXX	± 0.05	
ANGLES	$\pm 1^\circ$	

TITLE Standard, Assy Lock 6Pin M Conn F Pin			
SCALE 3:2	SIZE A4	SHEET 1 OF 1	
REV. B	WC-REV. A.4	CC : Inspection item	

Amphenol LTW
安費諾亮泰企業股份有限公司

ITEM NO BBD-06BMFA-LL7001	DRAWN BY Vicky	DATE 2014-12-10
DWG NO BBD-06BMFA-LL7001	CHECKED BY Sam	DATE 2014-12-10
CUSTOMER ALTW	APPROVED BY Rita	DATE 2014-12-10

