

- NOTES:
- ASSURE ASSEMBLY CAPABILITY BY MATCHING WITH MATING PART
  - DIMENSIONS IN [ ] ARE IN MILLIMETERS

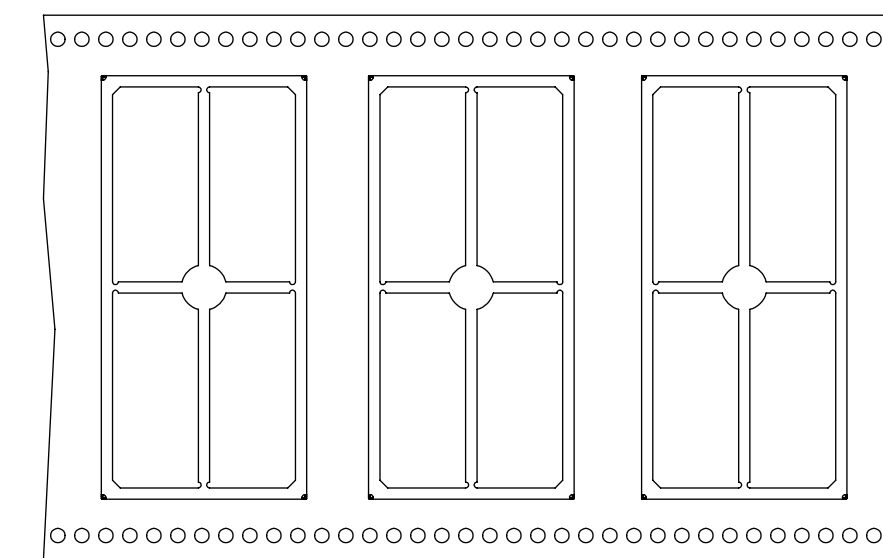

CARRIER TAPE SPECIFICATIONS						
PART NUMBER	DESCRIPTION	OVERALL DIMENSIONS	OVERALL HEIGHT	CARRIER TAPE WIDTH	CARRIER TAPE PITCH	PARTS PER REEL
SMS-461F	FRAME	1.070 X 2.206 [27.18 X 56.03]	.236 [5.99]	72 mm	40 mm	200
SMS-461C	COVER	1.094 X 2.230 [27.79 X 56.64]	.118 [3.00]	N/A	N/A	BULK PACK

THIS DOCUMENT CONTAINS PROPRIETARY INFORMATION OWNED BY LEADTECH OR DEVELOPED AT ITS OWN PRIVATE EXPENSE AND MAY NOT BE USED, REPRODUCED, COPIED, OR DISCLOSED IN WHOLE OR IN PART FOR ANY PURPOSE INCLUDING DESIGN, MANUFACTURE OR PROCUREMENT WITHOUT THE WRITTEN PERMISSION OF LEADTECH. LEADTECH DOES NOT GUARANTEE OR WARRANT THE PERFORMANCE CHARACTERISTICS.

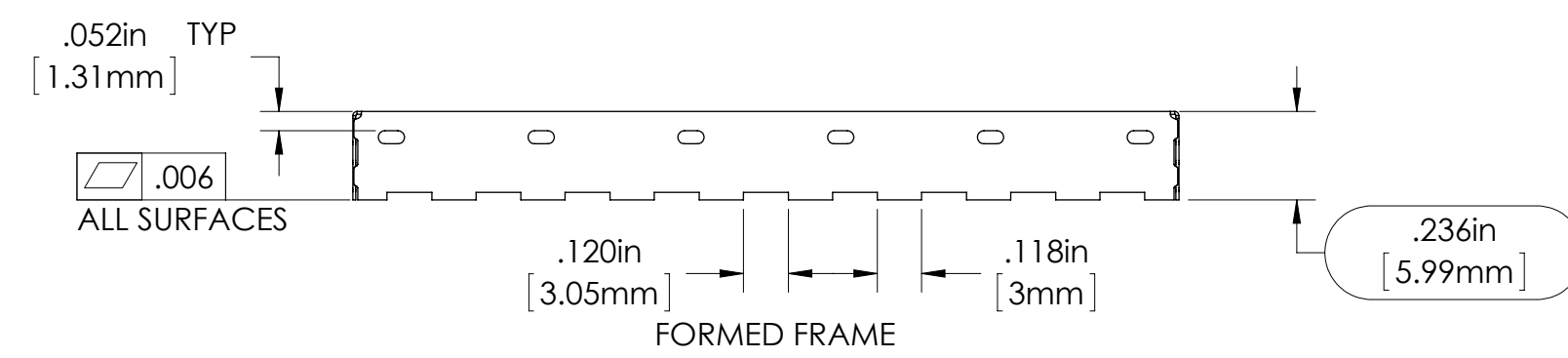
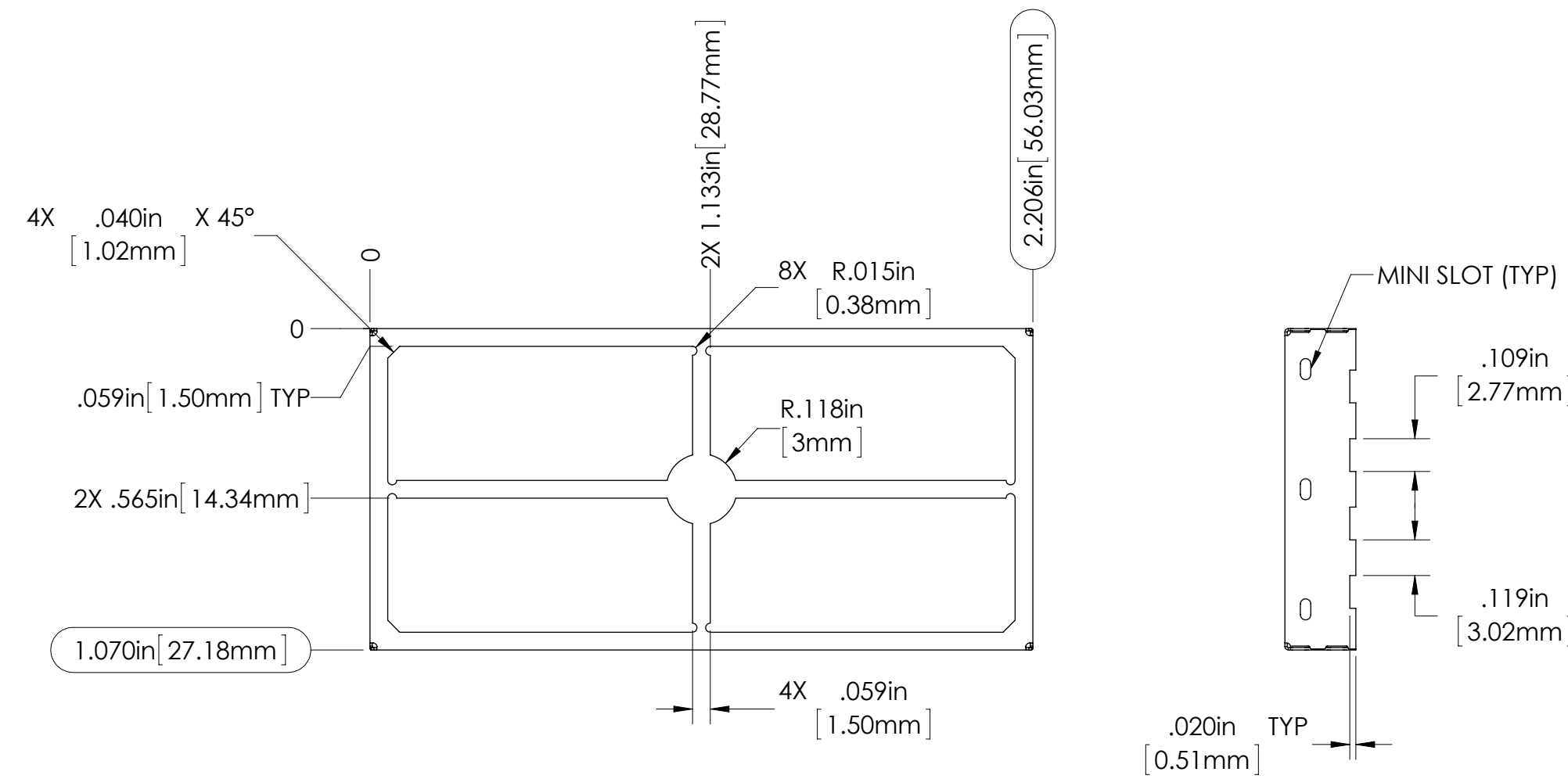
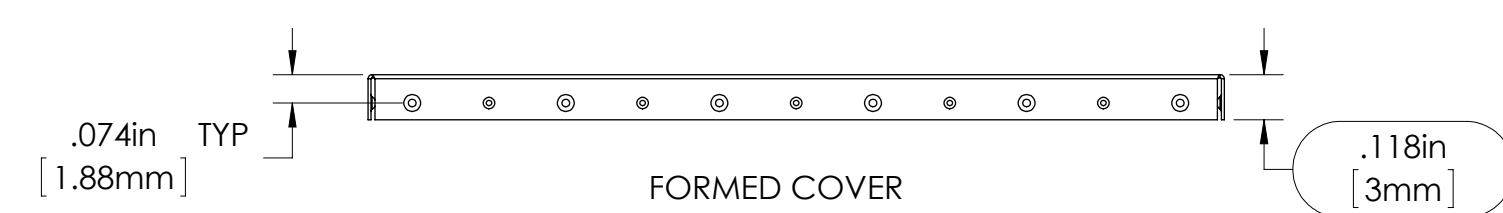
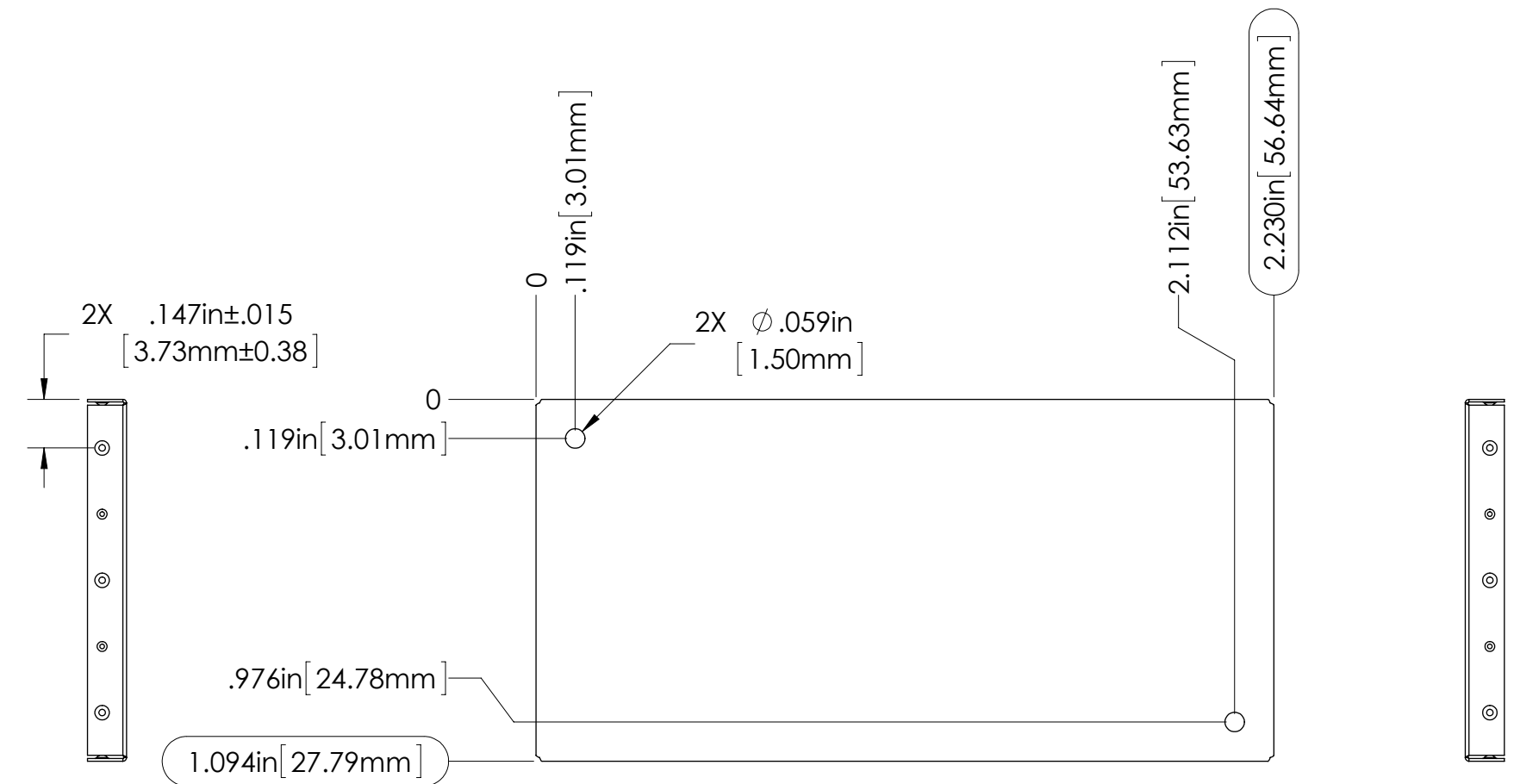
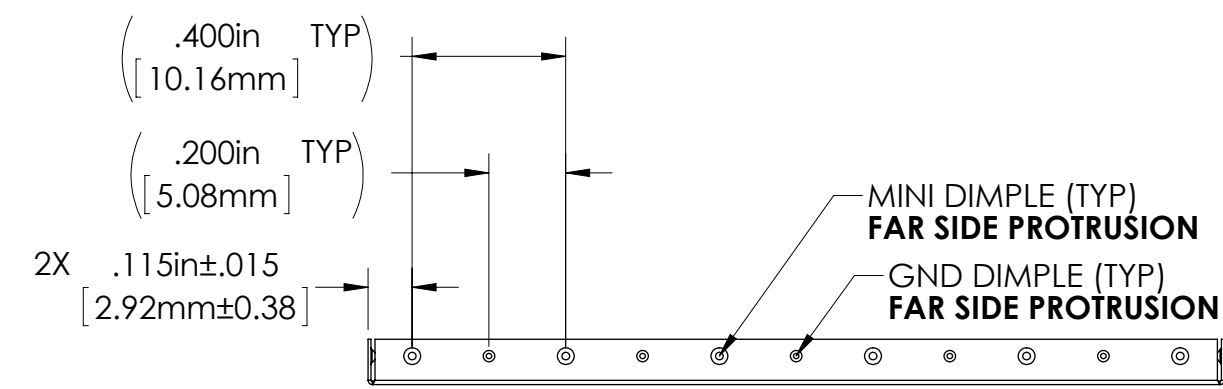
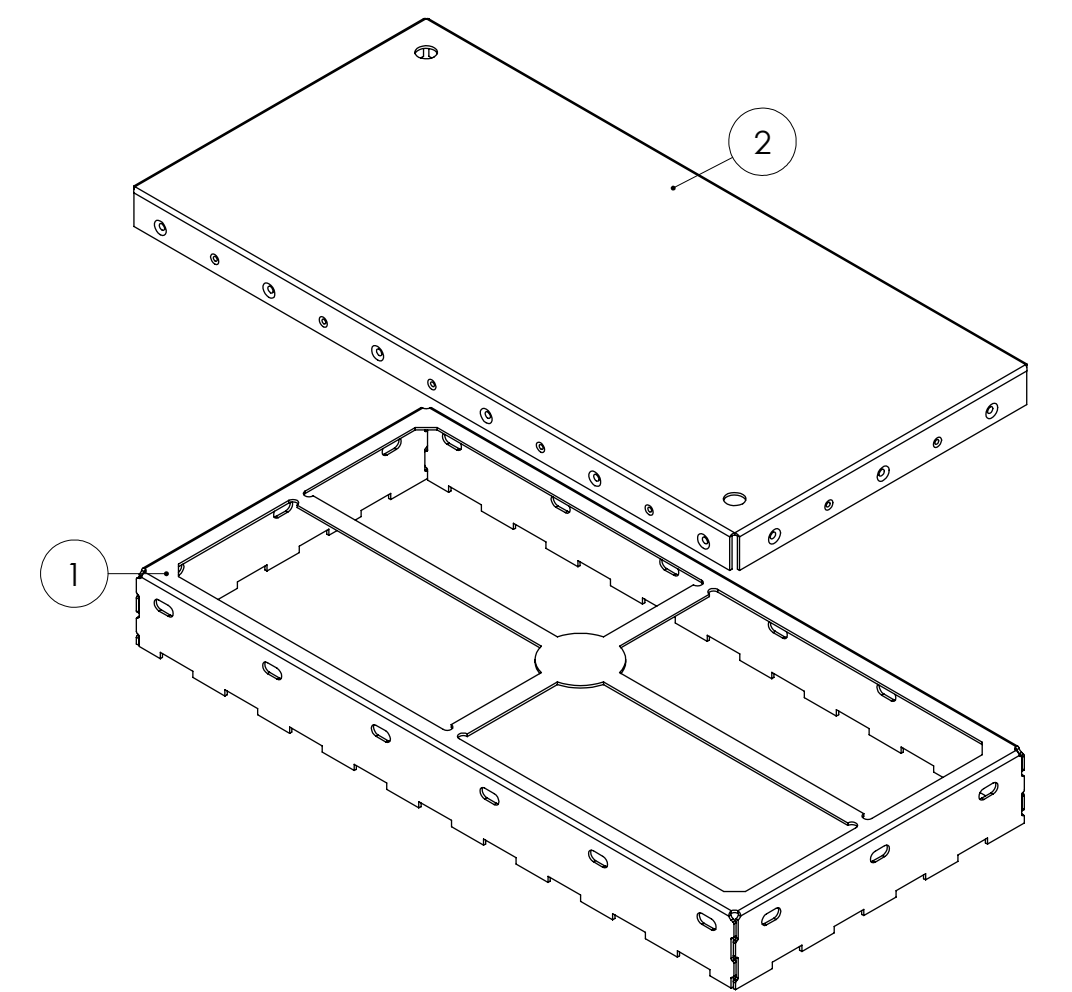
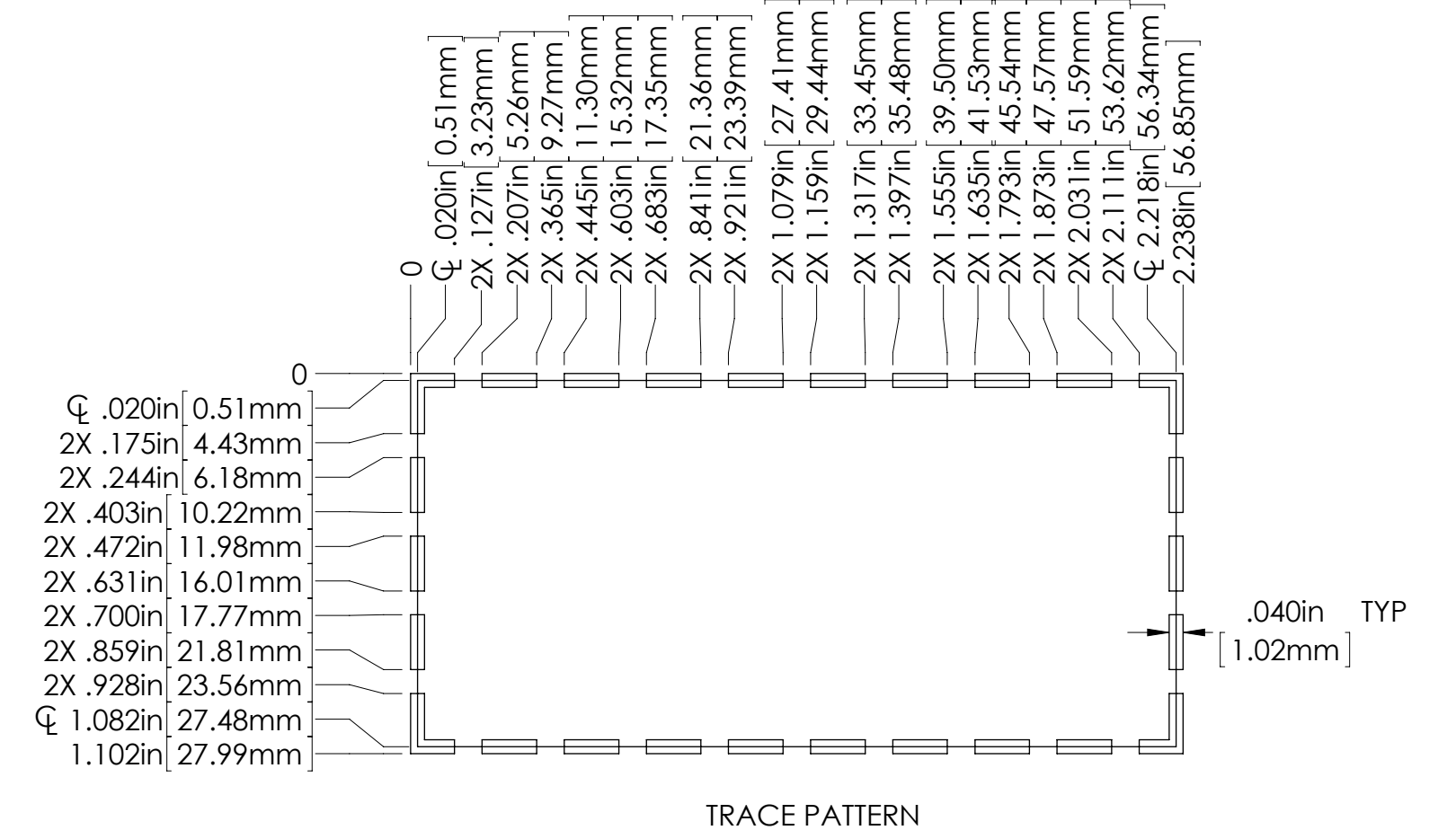

ITEM NO.	PART NUMBER	DESCRIPTION	QTY.
1	SMS-461F	FRAME	1
2	SMS-461C	COVER	1

UNLESS OTHERWISE SPECIFIED:  
 - ALL DIMENSIONS ARE IN INCHES  
 - PART SHALL BE FREE OF BURRS AND SHARP EDGES  
 - ALL DIMENSIONS SHOWN APPLY AFTER PLATING AND COATINGS  
 - ROHS COMPLIANT PER EU DIRECTIVE 2011/65/EU  
 - POI = POINT OF INTERSECTION

THIRD ANGLE PROJECTION

LEADER TECH  
 a HEICO company  
 The Leading Edge in PWB Mounting Technology

TITLE: SURFACE MOUNT SHIELD

DRAWN BY: JG 2015-10-30 APPROVED BY:

SCALE: 2:1 DWG. NO.: D SHEET: 1 OF 1

MATERIAL: MATTE 0.008" [0.20] PRE TIN STEEL