



Parameters	Ratings	Units
Blocking Voltage	600	V_p
AC Operating Voltage	260	V_{rms}
Load Current ¹	250	mA_{rms}
On State Voltage Drop	3	V_{rms} (at $I_L = 250mA_{rms}$)

¹ One Pole Operating

Features

- Load Current up to 250 mA_{rms}
- 600 V_p Blocking Voltage
- 5mA Sensitivity
- Zero-Crossing Detection
- DC Control, AC Output
- Optically Isolated
- TTL and CMOS Compatible
- Low EMI and RFI Generation
- High Noise Immunity
- Machine Insertable, Wave Solderable
- Flammability Classification Rating of V-0

Applications

- Programmable Control
- Process Control
- Power Control Panels
- Remote Switching
- Gas Pump Electronics
- Contactors
- Large Relays
- Solenoids
- Motors
- Heaters

Description

The CPC1961 is a dual single-pole AC solid state relay that uses optical coupling with dual monolithic SCR outputs to produce an alternative to optocoupler and Triac circuits. The CPC1961 switches are robust enough to provide up to a 600 V_p blocking voltage. In addition, tightly controlled zero cross circuitry ensures switching of AC loads without the generation of transients. The input and output circuits are optically coupled to provide 3750 V_{rms} of isolation and noise immunity between control and load circuits. As a result the CPC1961 is well suited for industrial environments where electromagnetic interference would disrupt the operation of electromechanical relays. The CPC1961 is offered in a space saving 8-pin DIP package with two independent switches.

Approvals

- UL Recognized Component: File 69938
- CSA Certified Component: File 043639

Ordering Information

Part #	Description
CPC1961G	8-Pin Dip (50/Tube)
CPC1961GS	8-Pin Surface Mount (50/Tube)
CPC1961GSTR	8-Pin Surface Mount (1000/Reel)

Pin Configuration

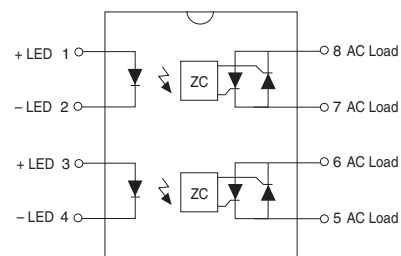

Absolute Maximum Ratings @ 25°C

Parameter	Ratings	Units
Blocking Voltage	600	V _P
Reverse Input Voltage	5	V _P
Input Control Current Peak (10ms)	50	mA
	1	A
Input Power Dissipation ¹	150	mW
Total Package Dissipation ²	800	mW
Isolation Voltage, Input to Output	3750	V _{rms}
Operational Temperature	-40 to +85	°C
Storage Temperature	-40 to +125	°C

Absolute Maximum Ratings are stress ratings. Stresses in excess of these ratings can cause permanent damage to the device. Functional operation of the device at conditions beyond those indicated in the operational sections of this data sheet is not implied.

¹ Derate linearly 1.33 mW / °C

² Derate linearly 6.67 mW / °C

Electrical Characteristics @ 25°C

Parameters	Conditions	Symbol	Min	Typ	Max	Units
Output Characteristics						
Operating Voltage Range	V _L	-	20	-	260	V _{rms}
Load Current ¹ , Continuous	V _L =120-240V _{rms}	I _L	0.005	-	250	mA _{rms}
Non-repetitive Single Cycle Surge Current	t ≤ 10ms	I _{TSM}	-	-	1	A
Off State Leakage Current	V _L =600V	I _{LEAK}	-	-	1	μA
On-State Voltage Drop	I _L =250 mA _{rms}	-	-	-	3	V _{rms}
Critical Rate of Rise ²	-	dV/dt	500	-	-	V/μs
Holding Current	I _F =5 mA	I _H	-	300	-	μA
Switching Speeds	I _F =5 mA	t _{on} t _{off}	-	-	0.5 0.5	cycles
Turn-on						
Turn-off						
Zero-Cross Turn-On Voltage ³	1st half-cycle	-	-	5	20	V
	Subsequent half-cycles	-	-	-	5	V
Operating Frequency	-	-	20	-	500	Hz
Load Power Factor for Guaranteed Turn-On ⁴	-	PF	0.25	-	-	-
Input Characteristics						
Input Control Current to Activate ⁵	-	I _F	-	1.2	5	mA
Input Voltage Drop	I _F =5mA	V _F	0.9	1.2	1.4	V
Input Drop-out Voltage	-	-	0.8	-	-	V
Reverse Input Current	V _R =5V	I _R	-	-	10	μA
Common Characteristics						
Input to Output Capacitance	-	C _{IO}	-	3	-	pF

¹ Maximum continuous load current of a single pole or the sum of the load currents with both poles operating simultaneously.

² Tested in accordance with EIA/NARM standard RS-443.

³ Zero Cross 1st half-cycle @ <100Hz

⁴ Snubber circuits may be required at low power factors.

⁵ For high noise environment use at least 10mA LED current.

PERFORMANCE DATA*

Typical LED Forward Voltage Drop
($I_F=5\text{mA}$, $T_A=25^\circ\text{C}$)

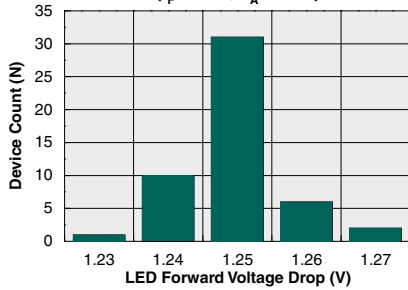

Typical On-State Output Forward Voltage Distribution
($I_F=5\text{mA}$, $I_L=250\text{mA}$, $T_A=25^\circ\text{C}$)

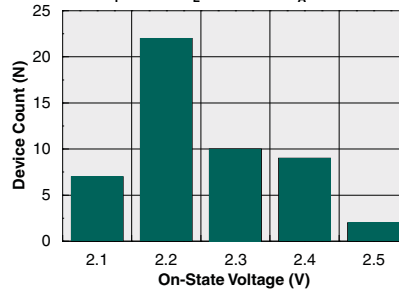

Typical Blocking Voltage Distribution
($I_F=0\text{mA}$, $T_A=25^\circ\text{C}$)

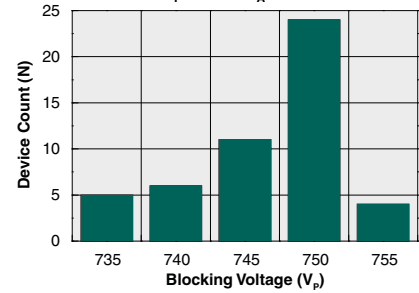

Typical I_F for Switch Operation
($I_L=250\text{mA}$, $T_A=25^\circ\text{C}$)

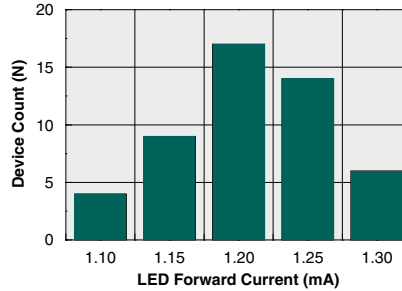

LED Forward Voltage vs. Temperature

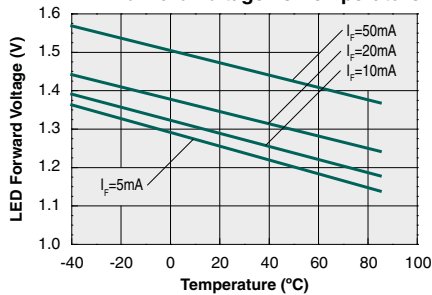

Typical I_F for Switch Operation vs. Temperature
($I_L=250\text{mA}$)

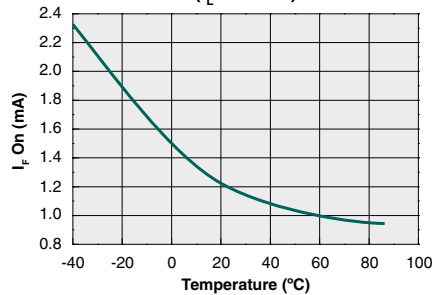

Typical I_F for Switch Dropout vs. Temperature
($I_L=250\text{mA}$)

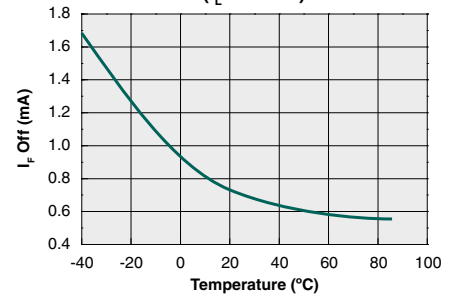

*The Performance data shown in the graphs above is typical of device performance. For guaranteed parameters not indicated in the written specifications, please contact our application department.

PERFORMANCE DATA*

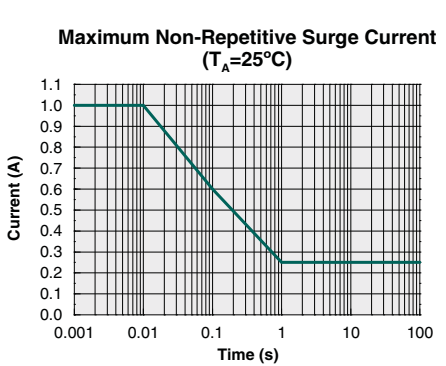
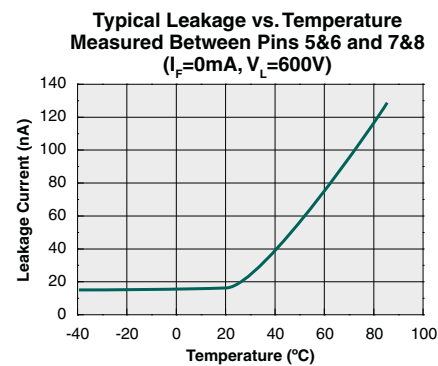
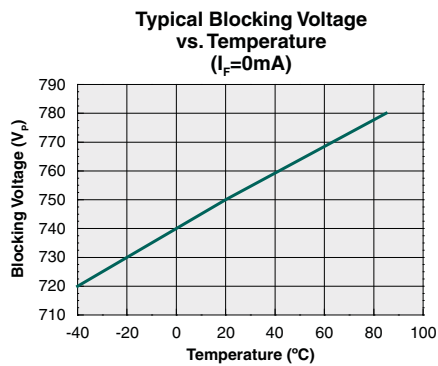
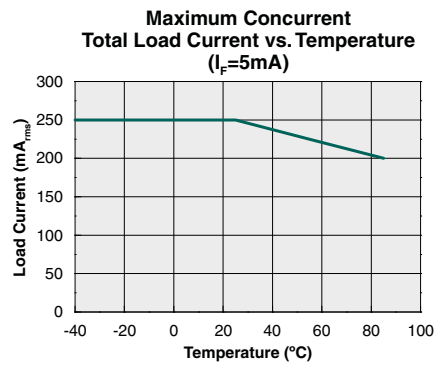
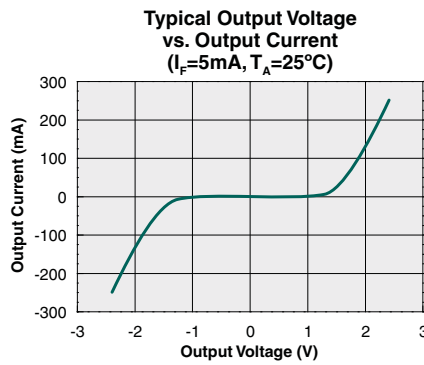
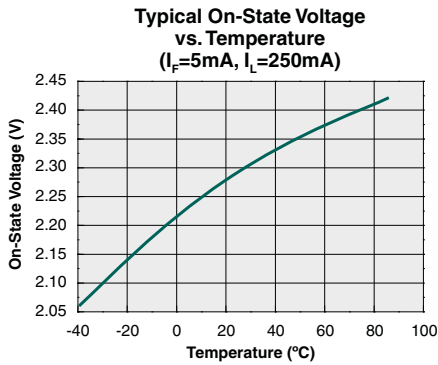

*The Performance data shown in the graphs above is typical of device performance. For guaranteed parameters not indicated in the written specifications, please contact our application department.

Manufacturing Information

Moisture Sensitivity



All plastic encapsulated semiconductor packages are susceptible to moisture ingress. IXYS Integrated Circuits Division classified all of its plastic encapsulated devices for moisture sensitivity according to the latest version of the joint industry standard, **IPC/JEDEC J-STD-020**, in force at the time of product evaluation. We test all of our products to the maximum conditions set forth in the standard, and guarantee proper operation of our devices when handled according to the limitations and information in that standard as well as to any limitations set forth in the information or standards referenced below.

Failure to adhere to the warnings or limitations as established by the listed specifications could result in reduced product performance, reduction of operable life, and/or reduction of overall reliability.

This product carries a **Moisture Sensitivity Level (MSL) rating** as shown below, and should be handled according to the requirements of the latest version of the joint industry standard **IPC/JEDEC J-STD-033**.

Device	Moisture Sensitivity Level (MSL) Rating
CPC1961G / CPC1961GS	MSL 1

ESD Sensitivity



This product is **ESD Sensitive**, and should be handled according to the industry standard **JESD-625**.

Reflow Profile

This product has a maximum body temperature and time rating as shown below. All other guidelines of **J-STD-020** must be observed.

Device	Maximum Temperature x Time
CPC1961G / CPC1961GS	250°C for 30 seconds

Board Wash

IXYS Integrated Circuits Division recommends the use of no-clean flux formulations. However, board washing to remove flux residue is acceptable. Since IXYS Integrated Circuits Division employs the use of silicone coating as an optical waveguide in many of its optically isolated products, the use of a short drying bake could be necessary if a wash is used after solder reflow processes. Chlorine- or Fluorine-based solvents or fluxes should not be used. Cleaning methods that employ ultrasonic energy should not be used.



MECHANICAL DIMENSIONS

CPC1961G

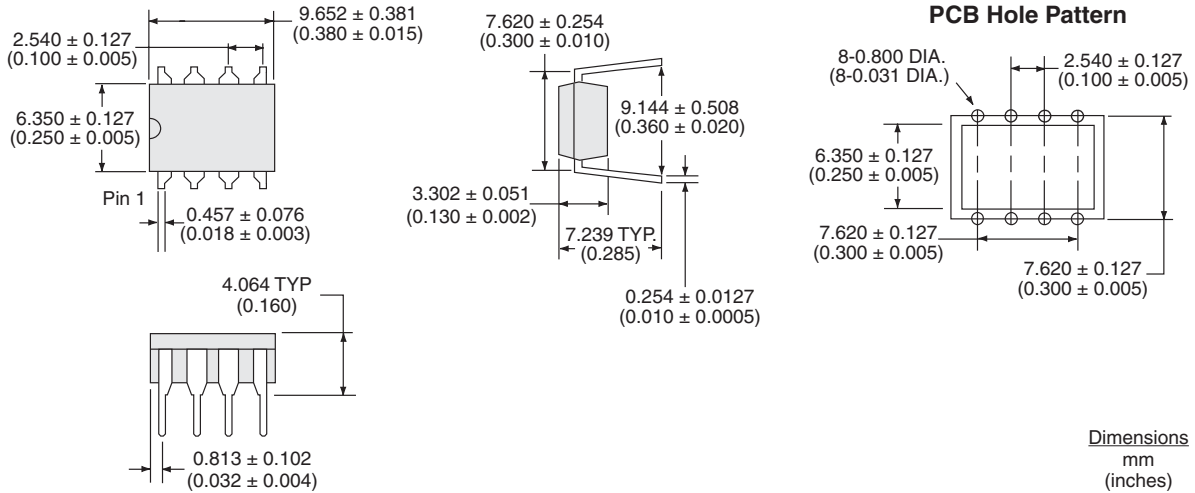

CPC1961GS

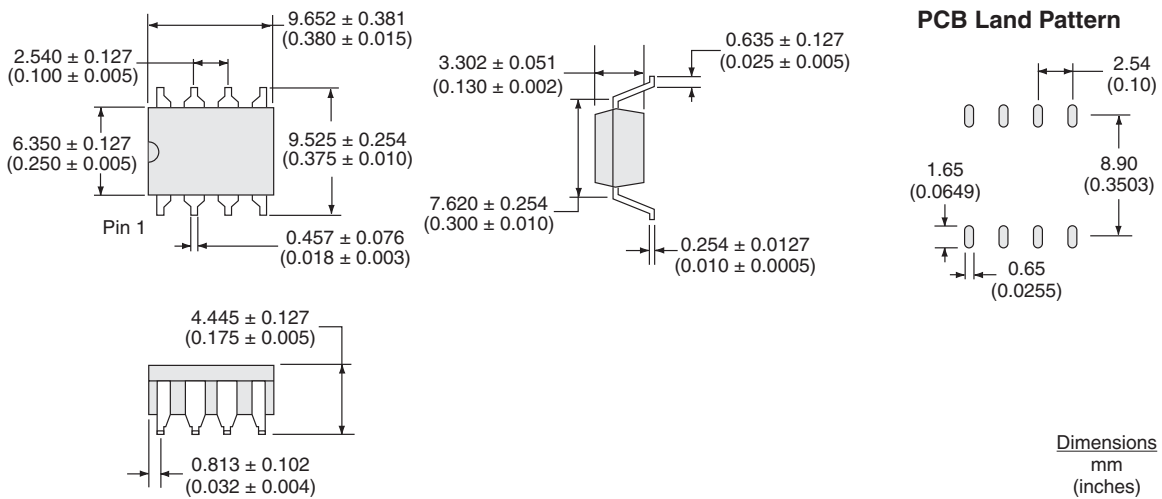

CPC1961GSTR Tape & Reel

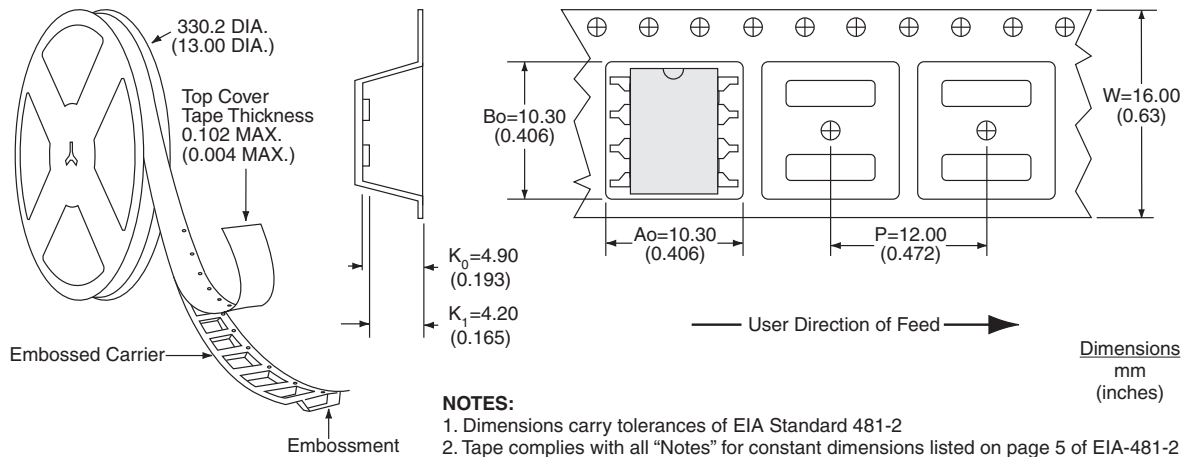

For additional information please visit our website at: www.ixysic.com

IXYS Integrated Circuits Division makes no representations or warranties with respect to the accuracy or completeness of the contents of this publication and reserves the right to make changes to specifications and product descriptions at any time without notice. Neither circuit patent licenses nor indemnity are expressed or implied. Except as set forth in IXYS Integrated Circuits Division's Standard Terms and Conditions of Sale, IXYS Integrated Circuits Division assumes no liability whatsoever, and disclaims any express or implied warranty, relating to its products including, but not limited to, the implied warranty of merchantability, fitness for a particular purpose, or infringement of any intellectual property right.

The products described in this document are not designed, intended, authorized or warranted for use as components in systems intended for surgical implant into the body, or in other applications intended to support or sustain life, or where malfunction of IXYS Integrated Circuits Division's product may result in direct physical harm, injury, or death to a person or severe property or environmental damage. IXYS Integrated Circuits Division reserves the right to discontinue or make changes to its products at any time without notice.