

# MAX16065 Evaluation Kit

## Evaluates: MAX16065

### General Description

The MAX16065 evaluation kit (EV kit) provides a proven PCB layout that facilitates evaluation of the MAX16065 flash-configurable system manager with nonvolatile fault memory. The EV kit is a fully assembled and tested surface-mount board.

The EV kit includes an on-board USB-to-JTAG and SMBus interface, facilitating communications between the host PC and the device. Two potentiometers and a set of loopback switches make it easy to evaluate the sequencing and monitoring functions of the device without requiring external power supplies. Headers are also provided to facilitate connection to an external application circuit.

This EV kit data sheet assumes basic familiarity with the device. Refer to the MAX16065/MAX16066 IC data sheet for more detailed information.

### Features

- ◆ **USB Interface to Host PC**
- ◆ **Easy-to-Use GUI Software**
- ◆ **On-Board Loopback Switches for Stand-Alone Evaluation**
- ◆ **On-Board Potentiometers to Simulate Fault Conditions**
- ◆ **Convenient Test Points and Headers for Easy Evaluation**
- ◆ **Proven PCB Layout**
- ◆ **Fully Assembled and Tested**

Ordering Information appears at end of data sheet.

### EV Kit Contents List

QTY	DESCRIPTION
1	Circuit board assembly: MAX16065EVKIT+
1	USB high-speed A-to-mini B cable, 5ft (1.5m)

### Component List

DESIGNATION	QTY	DESCRIPTION
C1, C2, C3, C16–C19	7	0.1 $\mu$ F $\pm$ 10%, 25V X7R ceramic capacitors (0603) TDK C1608X7R1E104K
C4, C13, C15	3	1 $\mu$ F $\pm$ 10%, 6.3V X5R ceramic capacitors (0603) TDK C1608X5R0J105K
C5–C8	4	18pF $\pm$ 5%, 50V C0G ceramic capacitors (0603) TDK C1608C0G1H180J
C9, C10	2	2.2 $\mu$ F $\pm$ 10%, 6.3V X5R ceramic capacitors (0603) TDK C1608X5R0J225K
C11	1	4.7 $\mu$ F $\pm$ 10%, 6.3V X5R ceramic capacitor (0603) TDK C1608X5R0J475K
C12	1	0.01 $\mu$ F $\pm$ 10%, 50V X7R ceramic capacitor (0603) TDK C1608X7R1H103K
C14	1	10 $\mu$ F $\pm$ 20%, 16V X5R ceramic capacitor (1206) TDK C3216X5R1C106M

DESIGNATION	QTY	DESCRIPTION
C20	1	1 $\mu$ F $\pm$ 20%, 16V X5R ceramic capacitor (0603) TDK C1608X5R1C105K
D1, D2	2	17.1V zener diodes (3 SOT23) Central Semi CMPZ5248B+
EXT PWR	1	Red PC-mount test point
F1	1	500mA fuse (2405)
GND	1	Black PC-mount test point
J1	1	6-pin header
J2	1	2-pin header
J3	1	8-pin header
J4	1	3-pin header
LED1–LED13	13	Green LEDs
P1	1	USB mini-B connector
P2	0	Not installed, 8-pin header
P3	0	Not installed, 10-pin header
P4	1	Dual-row, 10-pin protected header
P5	1	5-pin header
P6	1	15-pin header
P7	1	12-pin header

# MAX16065 Evaluation Kit

## Evaluates: MAX16065

### Component List (continued)

DESIGNATION	QTY	DESCRIPTION
P8	1	13-pin header
Q1, Q2	2	n-channel MOSFETs Fairchild FDC5612
R1, R2, R3	3	4.75k $\Omega$ $\pm$ 1% resistors (0603)
R4, R5, R6, R10, R12	5	221 $\Omega$ $\pm$ 1% resistors (0603)
R7, R13	2	10k $\Omega$ $\pm$ 1% resistors (0603)
R8, R9	2	33.2 $\Omega$ $\pm$ 1% resistors (0603)
R11	0	Not installed, resistor (2512)
R14	1	11k $\Omega$ $\pm$ 1% resistor (0805)
R15, R16	2	5k $\Omega$ slide potentiometers, 30mm
R17, R18, R19	3	10k $\Omega$ $\pm$ 1% resistors (0805)
RP1	1	8 x 220 $\Omega$ $\pm$ 5% resistor array
RP2	1	8 x 10k $\Omega$ $\pm$ 5% resistor array
S1–S6	6	8-position DIP switches
S7	1	SPST pushbutton switch
S8, S9	2	SPDT slide switches

DESIGNATION	QTY	DESCRIPTION
U1	1	Microcontroller (56 TQFN-EP) Maxim MAXQ2000-RBX+
U2	1	USB peripheral controller (24 TQFN-EP) Maxim MAX3420EETG+
U3	1	Dual, low-noise, LDO linear regulator (6 SOT23) Maxim MAX8882EUTAQ+
U4	1	12-channel flash-configurable system manager with nonvolatile fault registers (48 TQFN-EP) Maxim MAX16065ETM+
Y1	1	12MHz crystal (HCM49)
Y2	1	20MHz crystal (HCM49)
—	4	Shunts
—	1	MAX16065 EVALUATION KIT+

### Component Suppliers

SUPPLIER	PHONE	WEBSITE
Central Semiconductor	631-435-1110	www.centralsemi.com
Fairchild Semiconductor	888-522-5372	www.fairchildsemi.com
TDK Corp.	847-803-6100	www.component.tdk.com

**Note:** Indicate that you are using the MAX16065 when contacting these component suppliers.

## Quick Start

### Required Equipment

- MAX16065 EV kit
- User-supplied PC with a spare USB port

**Note:** In the following sections, software-related items are identified by bolding. Text in **bold** refers to items directly from the EV kit software.

### Procedure

The EV kit is fully assembled and tested. Follow the steps below to verify board operation:

- 1) Make sure that jumper J1 (VCC SEL) is in the 5.0V position. Also make sure that jumper J2 (CSBIAS) is closed, jumper J3 (I2C ADDR) is set to low, and jumper J4 (MON1-2 SE/DIFF) is in the 1-2 position (single ended).
- 2) Switches 1 and 2 in switch bank S1 (EN\_MON\_ loop-backs) should be in the off position. All other switches in switch banks S1 and S2 should be in the on position. All switches in switch banks S3 (EXT SEL), S4 (PC SEL), and S5 (PULLUP) should be in the on position. Switch bank S6 switches 1 and 8 should be in the on position, but all other switches should be off.
- 3) Connect the EV kit to a PC using the provided USB cable. LED4 lights to indicate that the EV kit has power.
- 4) Install and launch the EV kit software.
- 5) Select **I2C** from the **Connection** menu. Make sure that **Address** is 0xA0 in the **Address** dialog box. Click **OK**.
- 6) From the **File** menu, select **Open...**
- 7) Select the "MAX16065 EV Kit Demo.hex" file located in the software install folder and click **OK**. This action loads the device registers (but not the flash memory) with the demo configuration.
- 8) Click on the **Datalogging** tab. Move the enable switch (S9) to the on position and note the monitored voltages.

# MAX16065 Evaluation Kit

## Evaluates: MAX16065

### Detailed Description of Software

The MAX16065 EV kit software serves two purposes. One is to facilitate evaluation of the MAX16065 on the EV kit hardware. The second is to provide a convenient way to configure a MAX16065/MAX16066 in an application circuit.

#### Connecting to the EV Kit

Make sure the EV kit is connected to the PC by the USB cable. Launch the software and from the **Connection** menu, select **I2C** or **JTAG**. When the software is unconnected, the device configuration files can be edited locally. If you have been editing a local configuration and then connect to an EV kit, the **Load Register** dialog comes up (Figure 1) because the software needs to reconcile the local configuration with the contents of the part's registers. Select the **Do you want to use the values from the part registers and lose your configuration in progress?** radio button to overwrite the current configuration in memory with the values in the physical part's memory. Select the **Do you want to load your configuration in progress into the registers of the part? (The Flash memory of the part will remain unchanged)** radio button to take the current configuration and overwrite the registers of the physical part. Doing this immediately changes the behavior of the part.

If **I2C** is selected, the **Address** dialog comes up. Enter the slave address and click **OK**; the default is 0xA0, but other values can be used (see Table 3). **JTAG** supports JTAG chains of more than one device. If more than one device is present in the JTAG chain, a selection dialog box comes up, which lists devices by JTAG ID.

The software can be used without the EV kit connected by selecting **Unconnected** from the **Connection** menu.

#### Input/Output Tab

The **Input/Output** tab sheet (Figure 2) controls the configuration for the sequencing outputs and monitoring inputs of the device.

#### Input Configuration

Each of the 12 monitoring inputs of the device can be configured using the **Voltage Monitoring Input Configuration** group box. There are several settings, each corresponding to configuration bits in the device registers.

The **SE/Diff** column can configure channels 2, 4, 6, 8, 10, and 12 to act as differential inputs. These inputs are sensed relative to the previous channel. For example, if MON2 is configured as differential, the channel voltage measurement is (VMON1 - VMON2). MON1 continues to operate as normal.

The **MON Range** column sets up the input voltage range of the monitoring inputs. Select the range that matches closest to the desired nominal rail voltage. If the channel is not needed, select **Not Converted**.

**Over Voltage**, **Under Voltage**, and **Early Warning** columns contain the threshold voltages for each of these comparisons. Enter the voltage corresponding to each threshold voltage. The early warning threshold can act either as an undervoltage or overvoltage depending on the **Early Warning** radio button setting.

The **OV Critical**, **UV Critical**, and **EW Critical** columns control the critical fault enables for each threshold. If a threshold is configured as a critical fault and the voltage on the rail trips the comparator during normal operation, it causes the sequencer to power down all the outputs and triggers a nonvolatile fault log operation. During power-up and power-down, all thresholds are considered critical regardless of these settings.

The **Sequence Slot** column controls the sequencing slot at which the part begins to monitor the voltage. Generally the monitoring input should be placed in the same slot as the enable output (see the *Sequencing Output Configuration* section). If the input is not monitoring a power supply controlled directly by an enable output, the **Monitoring Only** settings can be used. Inputs configured this way are monitored only after successful sequencing has occurred on either the primary sequence or the secondary sequence.

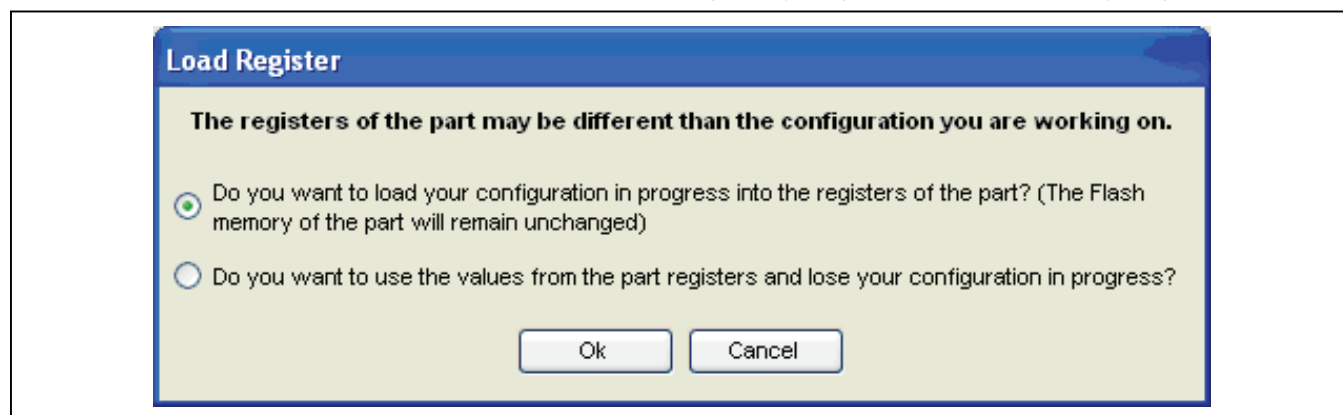

Figure 1. Load Register Dialog

# MAX16065 Evaluation Kit

## Evaluates: MAX16065

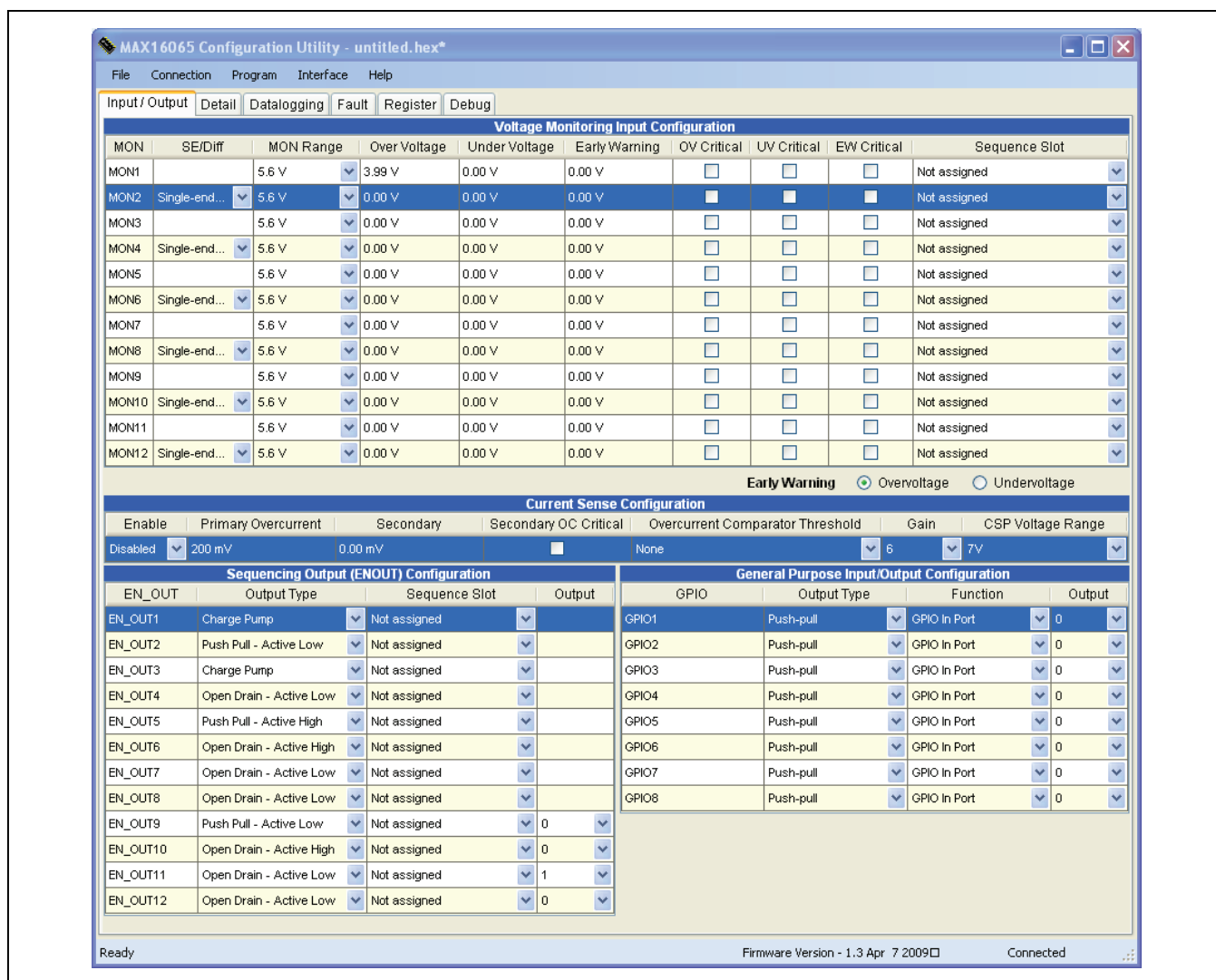

Figure 2. Input/Output Tab

### Current Sense Configuration

The device includes one dedicated current-sense amplifier. Turn it on using the **Enable** drop-down list. The current-sense amplifier monitors two overcurrent thresholds: primary and secondary. The **Primary Overcurrent** setting is controlled by the **Gain** drop-down list, which also sets the gain of the current-sense amplifier. Enter a threshold voltage into the **Secondary** text box to set that threshold. If a fault on this threshold should trigger a fault power-down and the nonvolatile fault log operation, place a check in the **Secondary OC Critical** checkbox. To prevent nuisance triggers on the primary overcurrent threshold, configure the **Deglintch Delay**.

The device also monitors the voltage at the CSP pin. To set the voltage range to encompass the maximum  $V_{CSP}$  voltage, use the **CSP Voltage Range** drop-down list to select the 7V or 14V range.

### Sequencing Output (ENOUT) Configuration

The device can control up to 12 power supplies using their enable inputs or (on up to 8 of those supplies) series-pass n-channel MOSFETS in series with the power-supply outputs. Set the output type and polarity using the **Output Type** column drop-down lists. The charge-pump setting is available only on EN\_OUT1–EN\_OUT8. Set the sequencing slot assignment or configure the EN\_OUT\_ as a general-purpose input or output (EN\_OUT9–EN\_OUT12 only) using the **Sequence Slot** column drop-down lists. The sequencer begins at slot 1 and steps through each sequencing slot until power-up completes. Each output turns on at the appropriate time slot. Set the sequence delays on the **Detail** tab sheet (Figure 3).

The **Output** column drop-down lists set the state of an EN\_OUT\_ configured as a general-purpose output. This setting can be stored in flash memory, setting the power-up state of the pin.

# MAX16065 Evaluation Kit

## Evaluates: MAX16065

### General-Purpose Input/Output Configuration

The device has eight general-purpose input/output pins that can be configured for a variety of purposes. Configure whether a GPIO should be open-drain or push-pull using the **Output Type** column drop-down lists.

The **Function** column drop-down lists control the purpose of each GPIO. See Table 1 for a summary of the available options.

The **Output** column drop-down lists set the state of the pin when configured as a GPIO out port. This setting can be stored in flash memory, setting the power-up state of the pin.

### Detail Tab

The **Detail** tab sheet (Figure 3) contains additional configuration options for the device relating to fault behavior, sequencing, lock bits, the watchdog timer, and the reset output.

### Sequencing

The **Power Down** radio buttons in the **Sequencing** group box control whether a normal power-down occurs with the power supplies turning off in reverse sequence or simultaneously all at once. The slot-delay settings control the time delays between each sequencing slot. Click the blue underlined timing to change it. **Fault Timer** controls the period of time allowed for a power supply to fall within its power-good thresholds from when it is turned on.

During a fault condition, the device can either shut off or try to sequence again, depending on the **Fault Behavior** setting. Select **Latchoff** from the drop-down list to have

the device shut down and not attempt to restart power sequencing. Select **Retry always** and select a delay period to have the device attempt sequencing again after the delay occurs. Select **Retry 1 time** or **Retry 3 times** to limit the number of retry attempts.

When a monitored voltage falls outside one of the programmable thresholds, the device's internal ADC repeats several conversions on the same channel. To trigger a fault condition, the voltage must remain outside the threshold for a number of ADC conversions programmed by the **Deglitch** setting. Allowable options are 2, 4, 8, or 16 cycles.

The **Final Slot** drop-down list selects the last slot of the primary sequence and sets the split between the primary and secondary sequencer. Refer to the MAX16065/MAX16066 IC data sheet for more information. **Current sequence state** displays the current state of the sequencer. **Failed slot in secondary sequence** displays which slot in the secondary sequence failed, if such a failure occurred. Both values are only displayed when connected to a physical device since they are contained in status registers that have no corresponding flash memory location.

If the **Software enable 1** checkbox is checked and the ENABLE switch on the EV kit is turned on, then the sequencer attempts to power up. If the **Software enable 2** checkbox is checked and the ENABLE2 switch (if the GPIO is configured accordingly) on the EV kit is turned on, then the sequencer turns on supplies in the secondary sequence. To use the ENABLE2 switch, the switch

**Table 1. GPIO Configuration Settings**

NAME	AVAILABLE ON GPIO	DESCRIPTION
GPIO In Port	GPIO1–GPIO8	General-purpose input.
GPIO Out Port	GPIO1–GPIO8	General-purpose output (open-drain or push-pull). The output state is controlled by the <b>Output</b> column.
Fault2	GPIO1–GPIO8	Configurable fault outputs (open-drain or push-pull). These are configured with the <b>Fault Pin Dependencies</b> control.
Fault1	GPIO1, 2, 4–7	
FAULTPU	GPIO3, 8	Power-up fault. Asserts if a tracking fault occurs during power-up.
Any_Fault	GPIO1, 3, 4, 5, 7	Fault output (open-drain or push-pull). Asserts low during any fault condition.
RESET2	GPIO2, 6, 8	Secondary sequence reset output.
OVERC	GPIO1–GPIO8	Primary overcurrent comparator output. Asserts low when the voltage between CSP and CSM exceeds the primary overcurrent threshold.
Manual Reset	GPIO1, 3, 5, 7	Manual reset input. When asserted low externally, this triggers a reset pulse on RESET.
WDO	GPIO2, 4, 6, 8	Watchdog output. Dedicated watchdog timer output.
WDI	GPIO1	Watchdog input. Input to the internal watchdog timer.
EXTFAULT	GPIO4, 8	External fault input/output.
EN2	GPIO5, 7	Secondary sequence-enable input.
MarginB	GPIO6	Margining control input. When pulled low externally, this disables threshold monitoring so margining can be performed.



# MAX16065 Evaluation Kit

## Evaluates: MAX16065

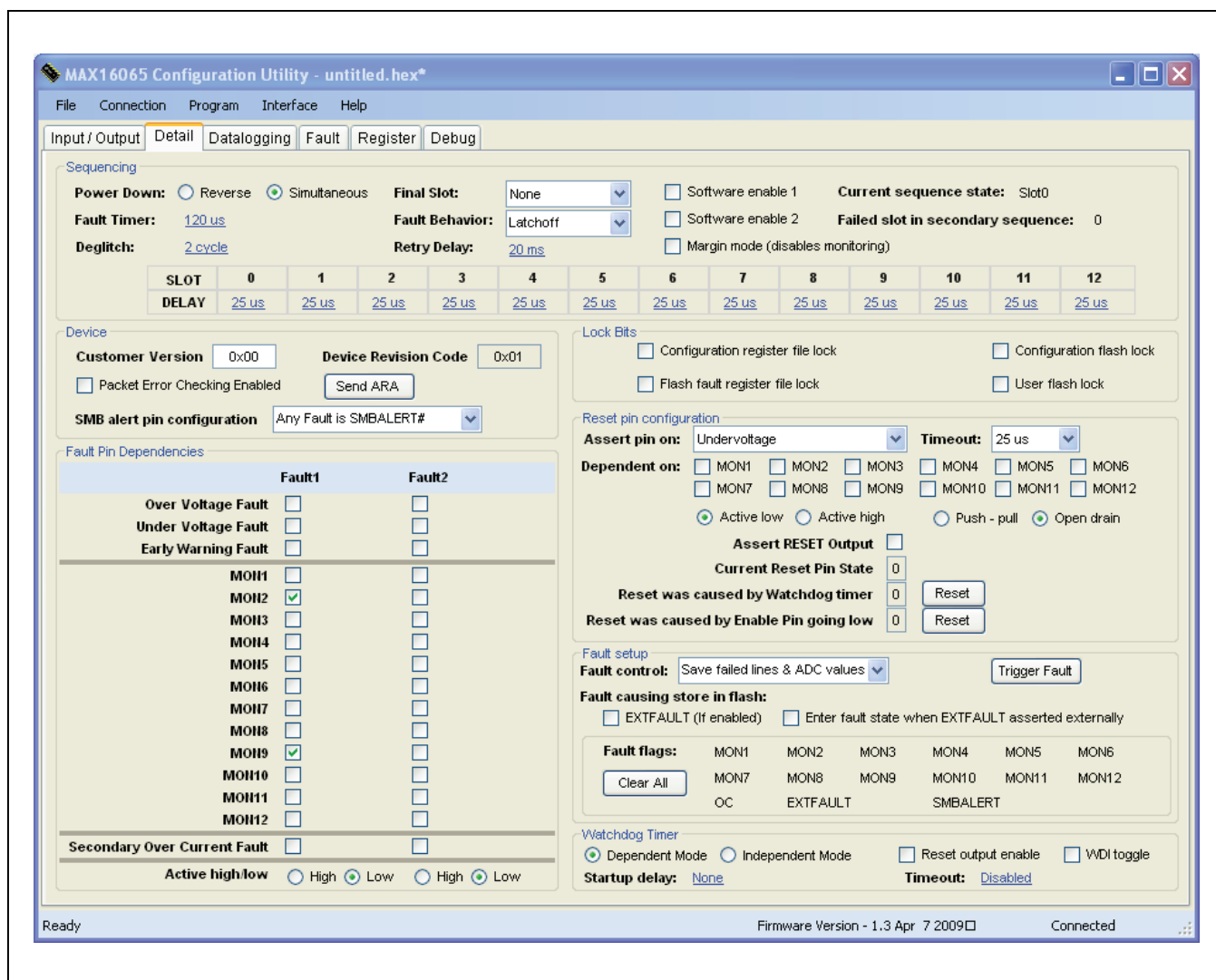

Figure 3. Detail Tab

must be connected to a GPIO input using the FEATURE (S6) switch bank, and that GPIO must be configured as EN2 (see Table 1 and the *Hardware Enables* section).

The **Margin mode (disables monitoring)** checkbox can temporarily disable voltage monitoring so that the connected power supplies can be margined or trimmed outside of their normal voltage limits, without triggering any faults.

### Device

The **Device** group box contains some general device parameters. **Customer Version** is a single general-purpose register that can be used as a loopback for testing purposes, or to store a configuration version number. **Device Revision Code** displays the revision of the MAX16065 silicon. The **Packet Error Checking Enabled** checkbox controls whether the device expects and verifies the checksum attached to SMBus traffic. If this option

is checked, the EV kit software needs to be configured so the SMBus host driver generates the checksum byte. Select **Tools** → **PEC Enabled**. If this is not done, the EV kit SMBus host can lose contact with the device. Toggle **Tools** → **PEC Enabled** to restore the connection.

The **SMB alert pin configuration** drop-down list sets the assignment of the SMBus ALERT# signal. A GPIO pin configured as FAULT1, FAULT2, or Any\_Fault can be configured to act as the SMBus ALERT# (see Table 1).

The **Send ARA** button is available only when connected using SMBus mode. When the SMBus ALERT# signal is asserted, press this button to send the alert response address (ARA) command on the SMBus to determine the slave address of the device causing the SMBus interrupt. On the device, the ALERT# signal remains asserted until the ARA is received.

# MAX16065 Evaluation Kit

## Evaluates: MAX16065

### Lock Bits

Checkboxes for several lock bits control access to different parts of the device's memory. **Configuration register file lock** prevents access to the volatile configuration registers. **Configuration flash lock** prevents access to the nonvolatile flash memory. **Flash fault register file lock** prevents the contents of the nonvolatile fault log memory from being overwritten. This lock is set automatically after a fault log operation occurs. **User flash lock** prevents access to the user flash (addresses 300h to 3FFh, excluding 3A0h to 3AFh).

### RESET Pin Configuration

The RESET output can be configured to depend on a number of different conditions. **Assert pin on** controls whether the output depends on overvoltage, undervoltage, early warning, or both undervoltage and overvoltage conditions. Check the appropriate monitoring inputs checkbox under **Dependent on** to set which thresholds the RESET output depends on. Note that the RESET output always depends on the primary sequence and only deasserts when the primary sequence is completed. If a fault occurs in any MON\_ input configured as a critical fault, the sequencer turns off the enable outputs assigned to the primary sequence and asserts RESET regardless of the settings in this section. Select the reset timeout using the **Timeout** drop-down list, and configure the output as push-pull or open drain and active high or active low by selecting the appropriate radio buttons.

Some controls do not match up with flash memory configuration registers and can only be accessed when the EV kit is connected to a part. These include the **Assert RESET Output** checkbox, the **Current Reset Pin State** indicator, and the reset reason indicators. To manually cause RESET to assert, check the **Assert RESET Output** checkbox. The **Current Reset Pin State** indicator shows the current state of the RESET output. The **Reset was caused by Watchdog timer** and **Reset was caused by Enable Pin going low** indicators show the reason for the last reset pulse. Clear these indicators using the adjacent reset buttons.

### Fault Pin Dependencies

Many GPIO pins can be configured as **Fault1** and **Fault2** outputs. Each output can be configured to depend on overvoltage, undervoltage, or early warning conditions on one or more input channels. When a selected channel voltage exceeds the voltage of the selected threshold, the output asserts. The outputs can be configured as active high or active low. Check the boxes under the appropriate row and column to enable or disable each setting.

### Fault Setup

The **Fault Control** drop-down list controls the data that is saved during a nonvolatile fault log operation. It can save the ADC conversion results, the fault flags, or both.

If **EXTFAULT (If enabled)** is checked, then an external assertion of the EXTFAULT input causes a nonvolatile fault log operation. If **Enter fault state when EXTFAULT asserted externally** is checked, then an external assertion of the EXTFAULT input causes the sequencer to turn off all the inputs and enter fault mode. If the EV kit is connected through SMBus or JTAG, then the fault flag indicators are visible. They indicate the fault status of each input, the current-sense amplifier, the SMBus ALERT signal, and the EXTFAULT input. Clear the flags by pressing the **Clear All** button.

To manually trigger a nonvolatile fault log operation, press the **Trigger Fault** button.

### Watchdog Timer

The internal watchdog timer can be configured in this group box. Click on the blue link next to **Timeout** to change the watchdog timeout period and enable the watchdog timer.

If the watchdog timeout period needs to be extended during initial startup to allow for an external microprocessor to complete a boot-up sequence, specify the startup timeout with the blue link next to **Startup delay**.

Normally the watchdog timer simply asserts WDO, but if desired, the watchdog timer can also assert RESET. Check the **Reset output enable** checkbox to enable this behavior.

If **Dependent Mode** is set, the watchdog timer turns on after power sequencing is complete and RESET deasserts. If **Independent Mode** is set, the watchdog timer turns on immediately and remains on regardless of the power sequencing state.

Check the **WDI toggle** checkbox to manually clear the watchdog timer and prevent a watchdog timeout.

### Datalogging Tab

The **Datalogging** tab sheet (Figure 4) is only visible when connected to an EV kit. Each of the monitored voltages and their thresholds can be observed on this tab, along with the voltage measured across the current-sense amplifier terminals. To see all the voltage inputs, use the scrollbar on the right side of the window.

Thresholds can be modified by either clicking on the blue links or manually dragging the dotted line on the waveform display. The fault mode and the input voltage ranges can also be modified, although all the configuration options available on this tab are duplicated from the **Input/Output** tab and modify the same registers.

### Fault Tab

Observe the contents of the nonvolatile fault registers using the **Fault** tab sheet (Figure 5). This tab is available only when connected to an EV kit. Each stored channel voltage is listed as a voltage calculated automatically using the input range selection.

# MAX16065 Evaluation Kit

## Evaluates: MAX16065

The failed line is marked using a red dot. If the fault occurred during sequencing, the **Sequencer State** row indicates the state in which the fault occurred, which can be a sequencer slot.

Press the **Clear fault register** button to reset the contents of the nonvolatile fault registers. If the lock bits are set, a dialog box allows you to clear them.

### Register Tab

The **Register** tab sheet (Figure 6) provides direct access to the registers and flash of the device.

### Configuration Registers Subtab

The **Configuration Registers** subtab sheet (Figure 6) provides low-level access to the configuration registers of the device when connected using SMBus or JTAG. Individual registers can be edited by clicking on the appropriate cell. To write the current configuration to flash, press the **Write registers to device Flash** button. This does the same thing as selecting **Save Registers to Flash** from the **Program** menu bar.

### Configuration Flash Subtab

The **Configuration Flash** subtab sheet (Figure 7) provides low-level access to the flash memory of the device.

Before editing any flash registers, read the contents of the flash memory into the software by pressing the **Read Configuration Flash** button. After editing flash registers by clicking on the appropriate cells, write the flash memory back out to the part by pressing the **Save Configuration Flash** button. To clear the device's flash memory, press the **Erase Configuration Flash** button.

### Non-Volatile Fault Flash Subtab

The **Non-Volatile Fault Flash** subtab sheet (Figure 8) provides read-only low-level access to the nonvolatile flash fault log memory.

### User Flash Subtab

User flash memory can be accessed from the **User Flash** subtab sheet (Figure 9). To read the user flash memory of the device, press the **Read User Flash** button. Click on any cell to edit the contents of the memory. When finished, press the **Save to User Flash** button to write the changes back out to the flash memory. To load a hex file into the user flash, press the **Load User Flash from HEX File** button. To save the contents of the user flash to a hex file, press the **Save User Flash to HEX File** button. The user flash is not stored with the current configuration file and must be stored separately using the buttons on this tab.

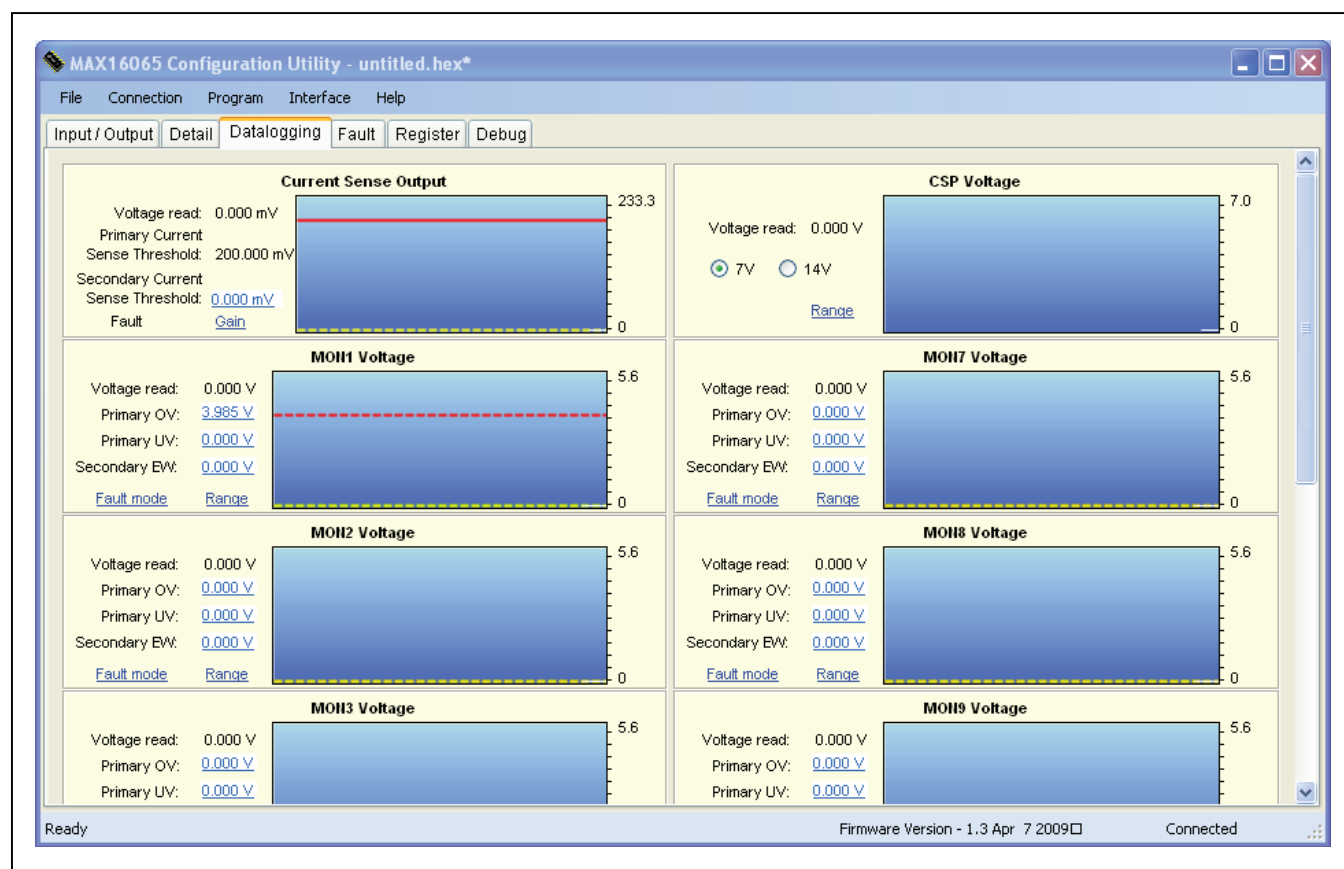

Figure 4. Datalogging Tab



# MAX16065 Evaluation Kit

## Evaluates: MAX16065

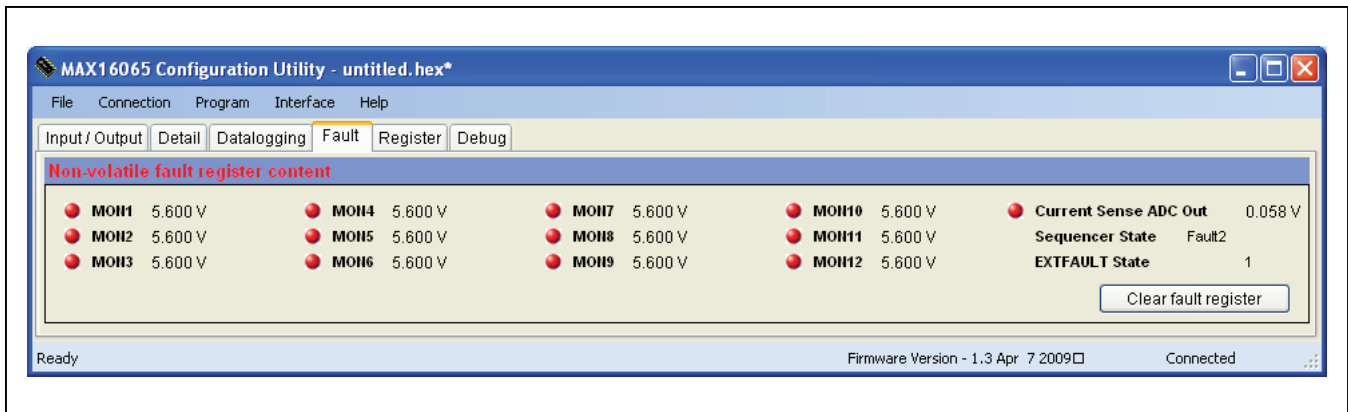

Figure 5. Fault Tab

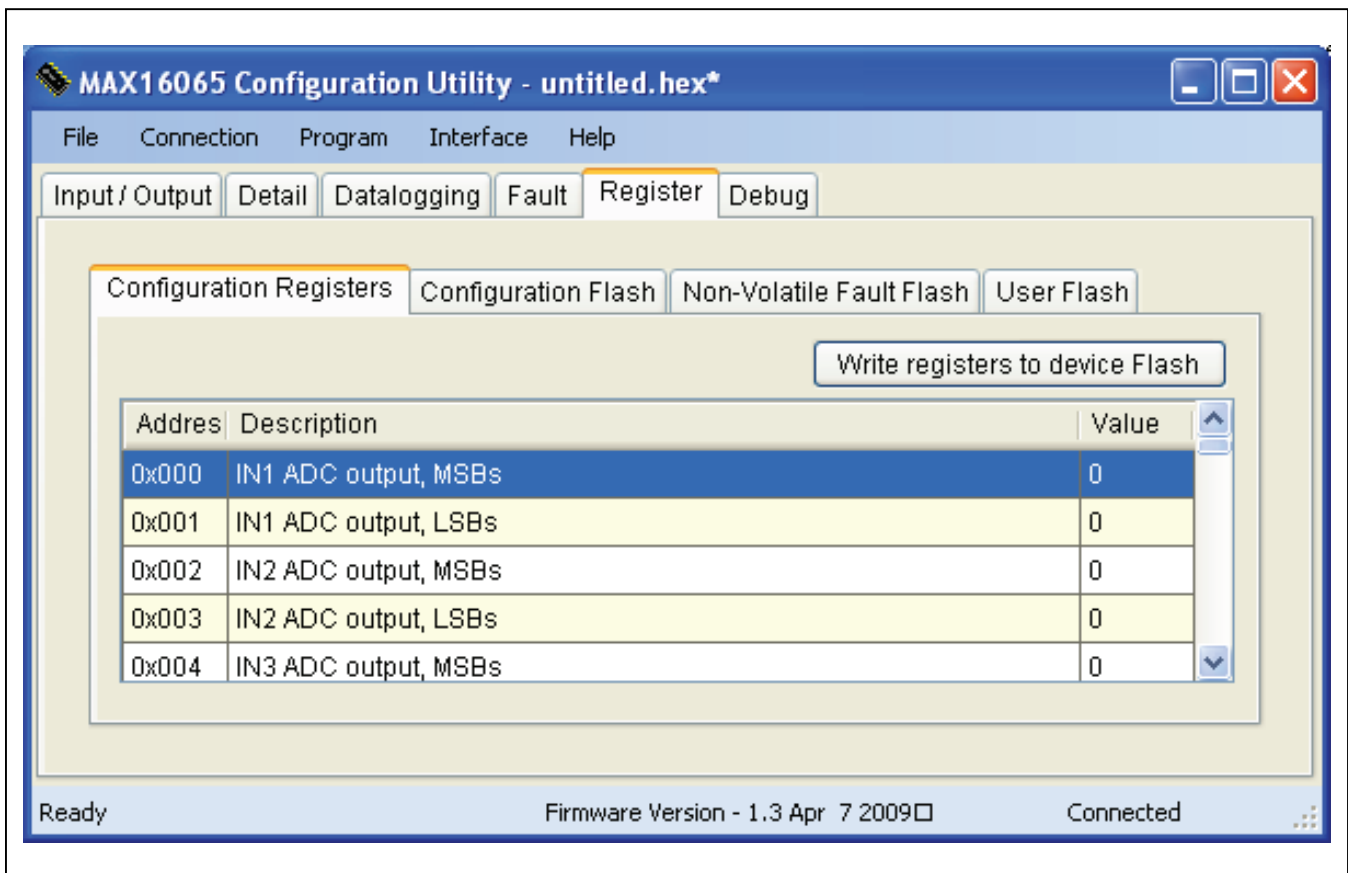

Figure 6. Configuration Registers Subtab

# MAX16065 Evaluation Kit

## Evaluates: MAX16065

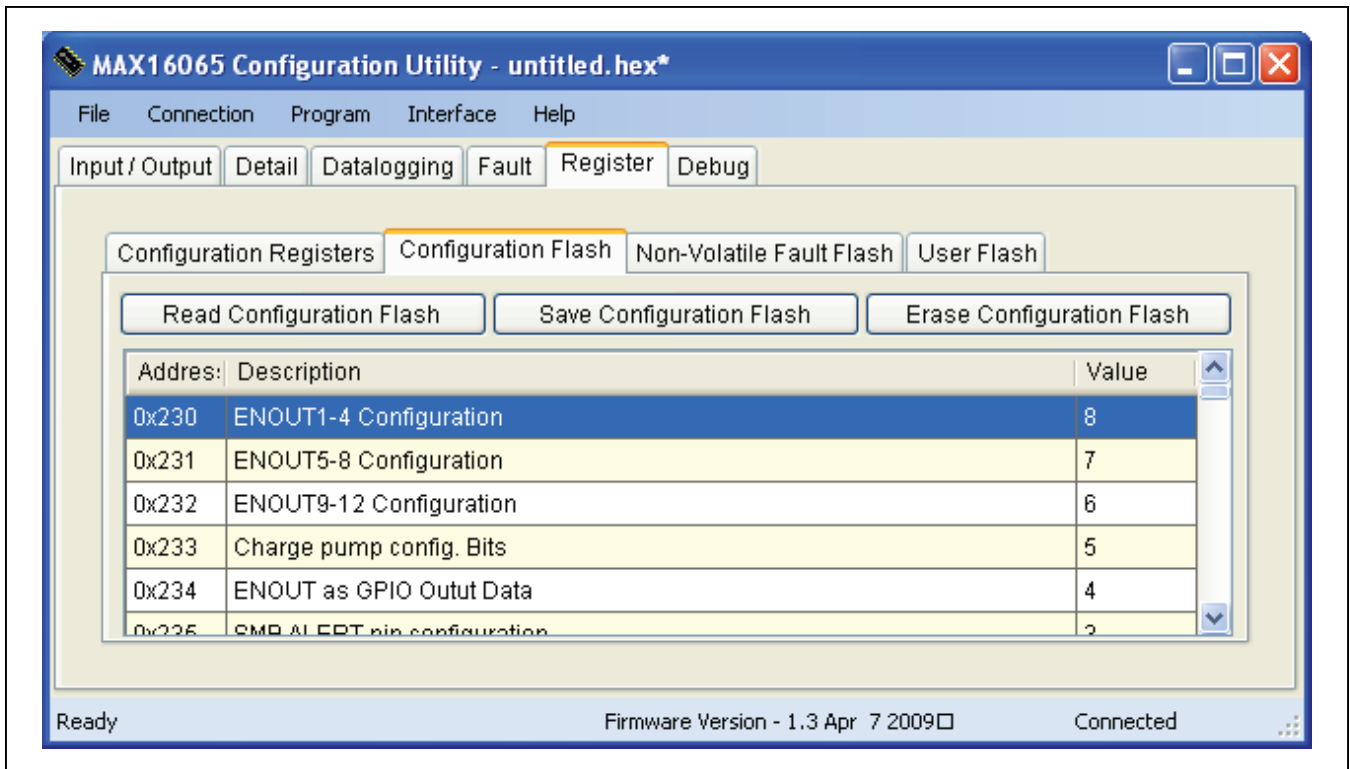

Figure 7. Configuration Flash Subtab

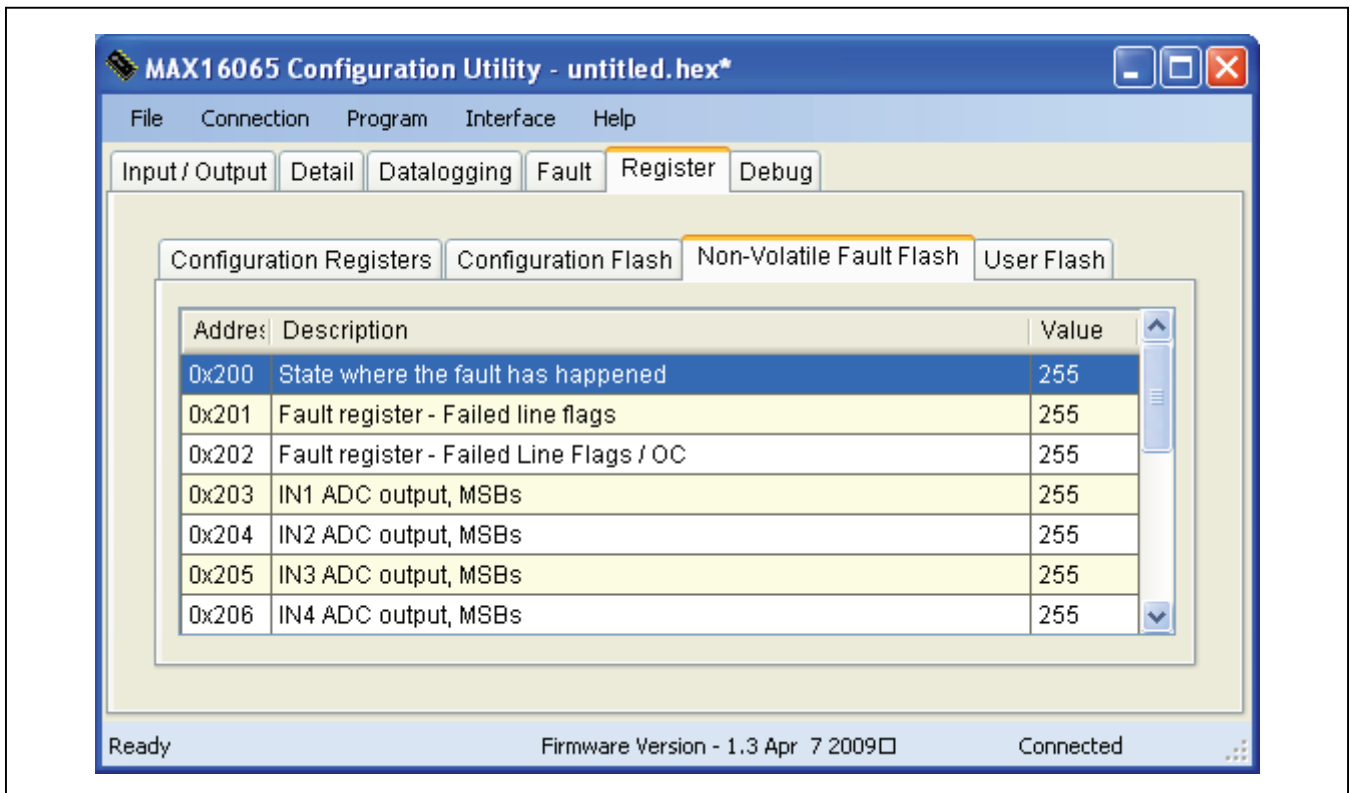

Figure 8. Non-Volatile Fault Flash Subtab

# MAX16065 Evaluation Kit

## Evaluates: MAX16065

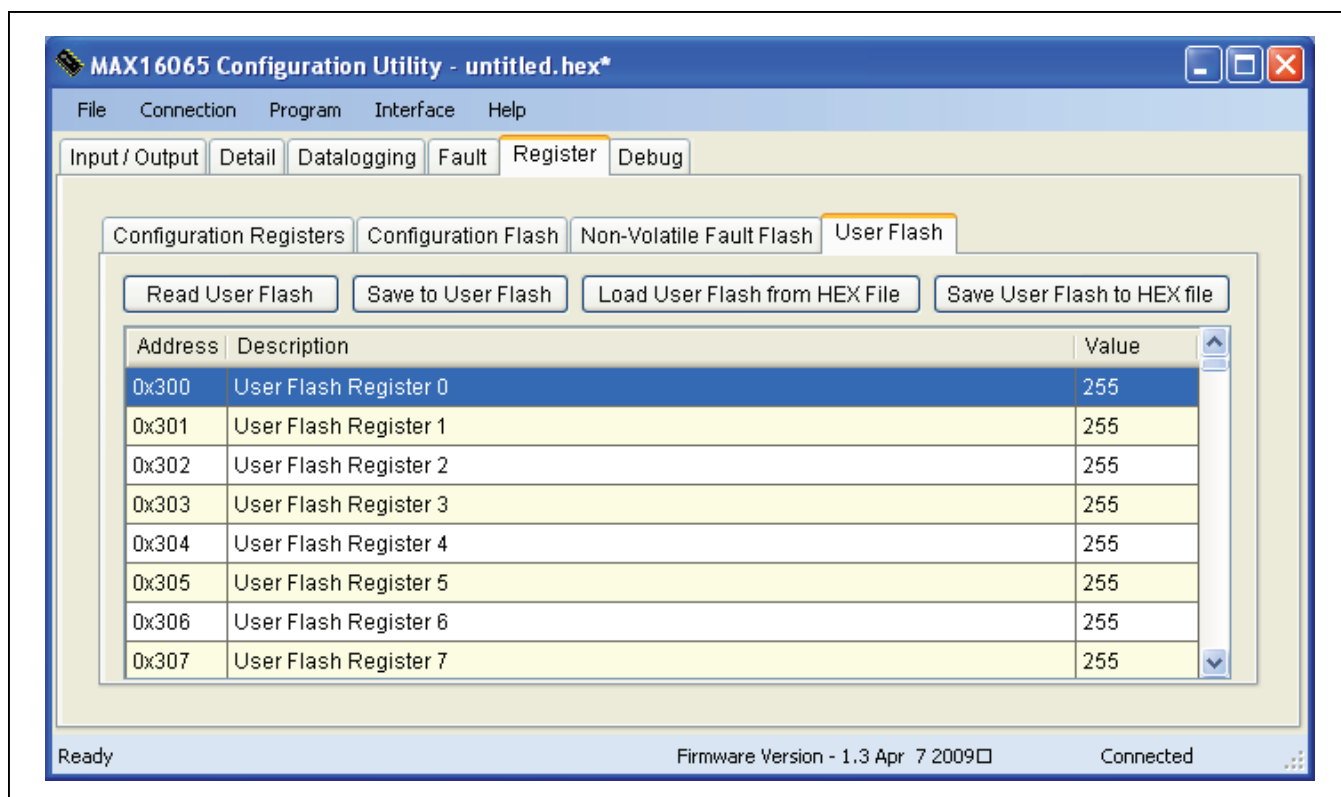

Figure 9. User Flash Subtab

### Menu Reference

#### File Menu

**New** clears the contents of the configuration registers. If connected to an EV kit, this writes zeros into all the configuration registers while preserving the contents of the flash memory.

**Save/Save As...** saves the current configuration to a standard Intel hex file.

**Open...** loads the configuration from an Intel hex file.

**Export to SVF File...** exports the current configuration to an SVF file, which is the standard format used by JTAG device programmers for production programming. The EV kit software cannot load SVF files, so be sure to save your work in hex format first.

**Exit** quits the program.

#### Connection Menu

**I2C** opens a connection to the device on the EV kit using the I<sup>2</sup>C/SMBus protocol. You must specify the slave address in order to connect. See Table 3 for a list of possible slave addresses. If you have been editing a local configuration and then connect to an EV kit, the **Load Register** dialog comes up (Figure 1) because the software needs to reconcile the local configuration with the contents of the part's registers. Select the **Do you want to use the values from the part registers and**

**lose your configuration in progress?** radio button to overwrite the current configuration in memory with the values in the physical part's memory. Select the **Do you want to load your configuration in progress into the registers of the part? (The Flash memory of the part will remain unchanged)** radio button to take the current configuration and overwrite the registers of the physical part. Doing this immediately changes the behavior of the part.

**JTAG** connects to the device on the EV kit using the JTAG protocol. The **Load Register** dialog may come up, as previously described.

**Unconnected** disconnects from the EV kit. The software can be used to create, edit, and view hex files locally without a connected EV kit.

#### Program Menu

This menu item is available when connected to an EV kit and provides commands to access the flash memory of the device.

**Save Registers to Flash** takes the contents of the configuration registers and writes it to the flash memory.

**Load Registers From Flash (Reboot)** takes the contents of the flash memory and writes it into the configuration registers.

# MAX16065 Evaluation Kit

## Evaluates: MAX16065

**Load HEX File to Flash...** takes the contents of a hex file and writes it directly to the flash memory. This command is useful for batch programming a device on a target board connected to the EV kit through the JTAG or SMBus connectors.

### Interface Menu

**Block Read Enabled** controls whether the SMBus host interface uses block read commands when polling the device.

**PEC Enabled** enables packet error check capability for the SMBus host interface. The device must be configured for PEC capability using the **Packet Error Checking Enabled** checkbox on the **Detail** tab sheet (Figure 3).

**Read All Registers** causes the host interface to read all the device registers into the PC.

**Autopoll** turns register polling on and off. When polling is on, the controls in all tabs are periodically refreshed from the physical registers. If polling is off, register contents can be read from the device by selecting **Read All Registers**.

### Help Menu

**About** launches the **About** dialog, which displays the software version. The firmware version is displayed on the status bar at the bottom of the main window.

## Detailed Description of Hardware

The MAX16065 monitors and sequences up to twelve power supplies. Eight configurable input/outputs indicate fault status information and control some functions of the IC. Figure 10 provides an overview of the major features of the EV kit PCB.

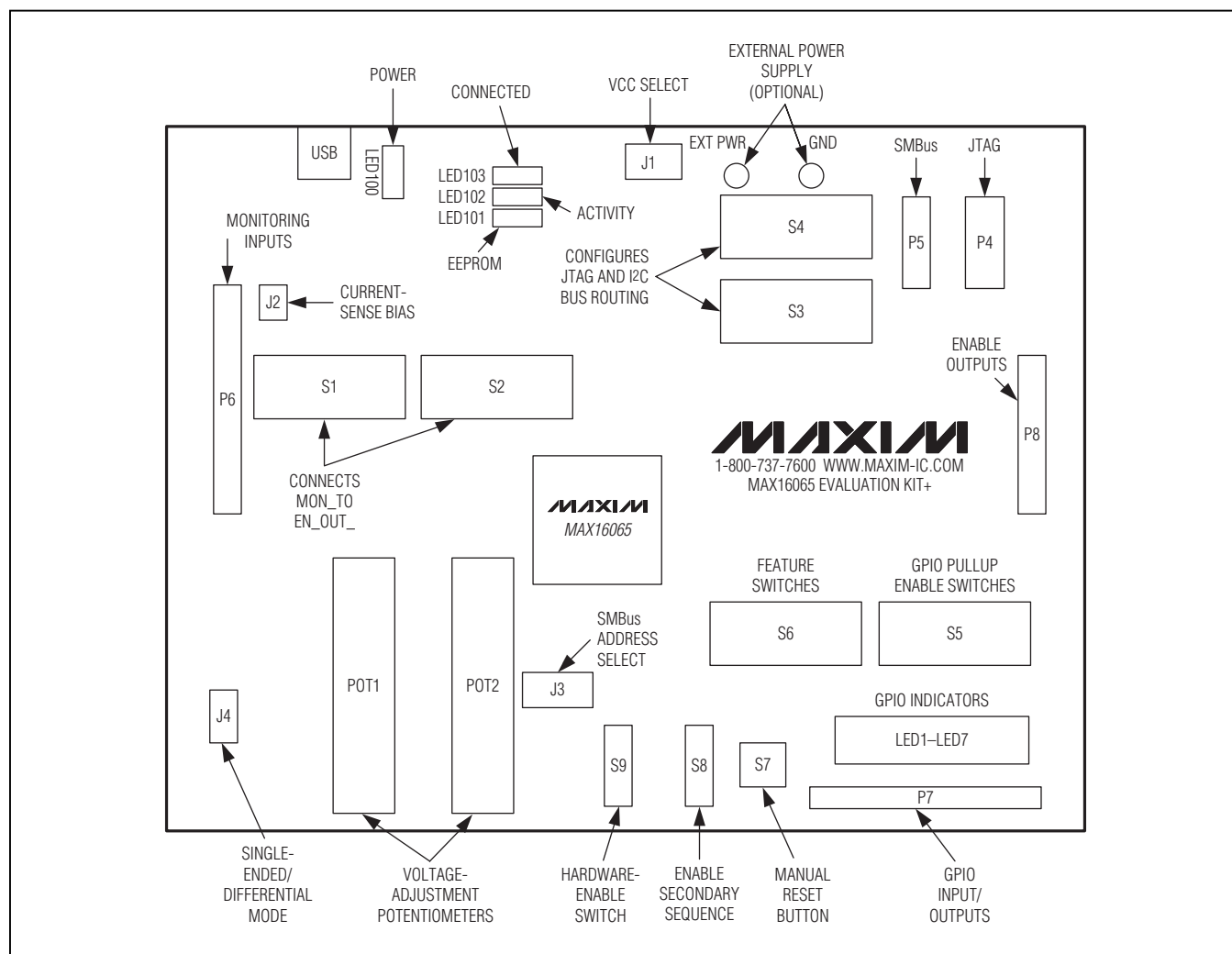

Figure 10. Evaluation Kit PCB Diagram

# MAX16065 Evaluation Kit

## Evaluates: MAX16065

### USB Host Interface

The EV kit includes a built-in USB-to-JTAG/SMBus host interface. The host interface uses the MAX3420 USB peripheral controller along with a MAXQ2000 microcontroller to communicate with the host PC and generate the SMBus/JTAG bus signals. Three indicators (LED1, LED2, and LED3) provide status information of the host interface. LED1 lights during EEPROM write operations, LED2 lights during SMBus or JTAG bus activity, and LED3 lights when the software is connected to the EV kit.

To facilitate prototype development and programming, the host interface can be used to interface with a MAX16065 on another board by turning off switches 1–7 in switch bank S3 (EXT SEL). This disconnects the on-board device from the SMBus and JTAG buses. Connect

to the other board using P4 and P5. The pinout of each connector is shown in Tables 4 and 5. Note that the SMBus pullup resistors (R1, R2, and R3) are located on the EV kit host interface.

The on-board device can be connected to an external SMBus or JTAG interface by turning switch bank S4 (PC SEL) switches 1–7 off while keeping switch bank S3 (EXT SEL) switches 1–7 on. Connect the external interface to P4 for JTAG or P5 for SMBus. The device can be completely disconnected from the on-board USB host interface by using this technique while providing external power to EXT PWR (J1 must be in the EXT position).

Each interface can be disconnected or connected separately. SMBus uses switches 1, 2, and 3 on both S3 and S4 and JTAG uses switches 4–7 on both S3 and S4.

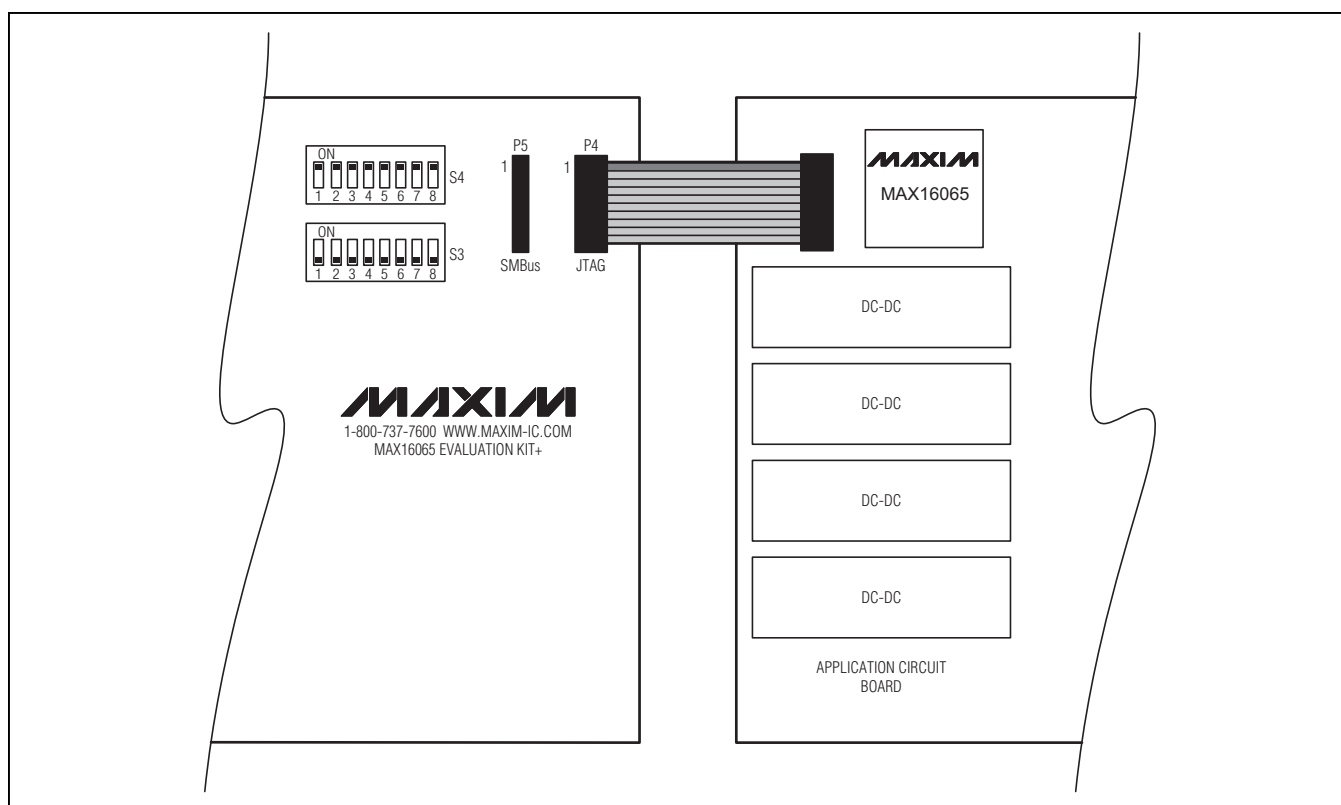

Figure 11. Connecting the EV Kit to an External Application Board Using the JTAG Interface



# MAX16065 Evaluation Kit

## Evaluates: MAX16065

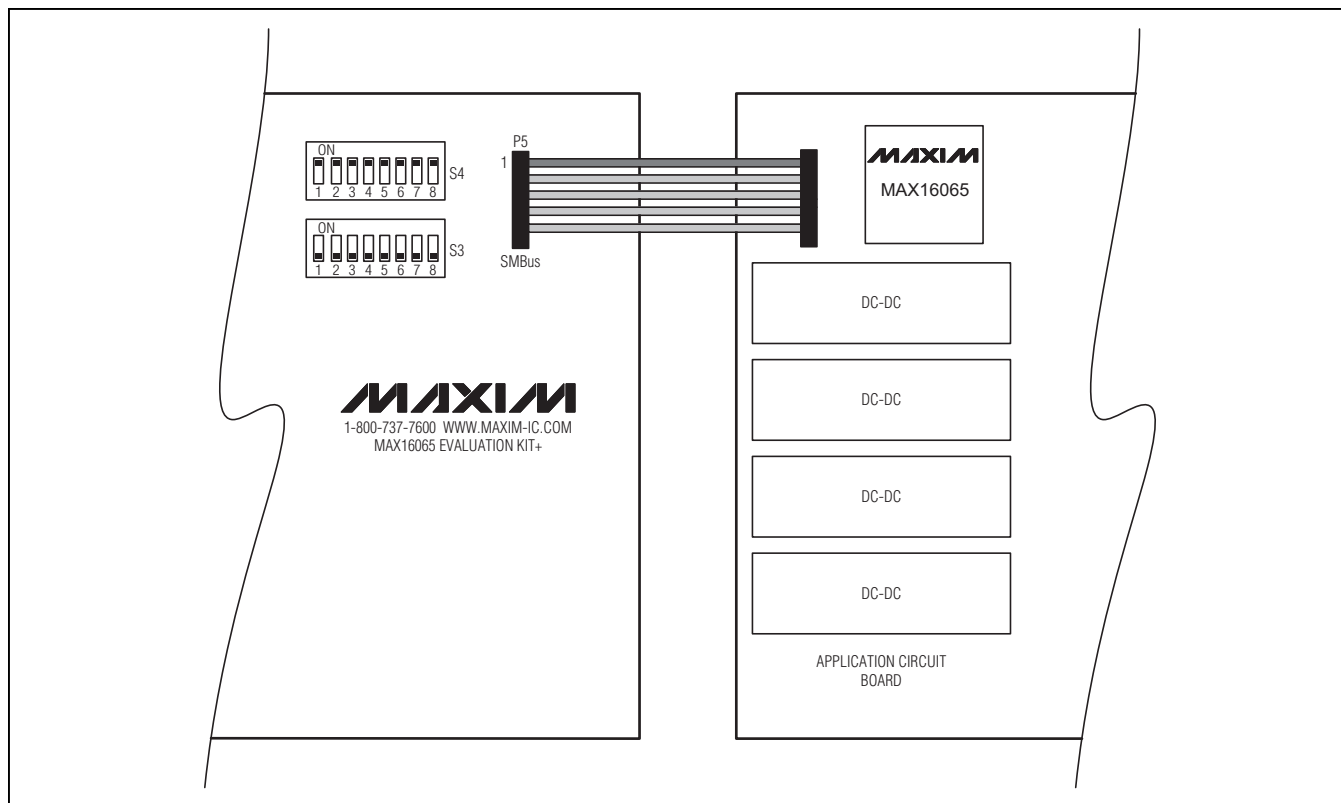

Figure 12. Connecting the EV Kit to an External Application Board Using the SMBus Interface

### Power Source

The device can be powered from one of three possible power supplies, controlled by jumper J1. To power directly from the USB 5V supply, place the jumper in the 5V position. When the jumper is in the EXT position, the device can be powered from an external power supply connected to the EXT PWR test point. Do not supply a voltage higher than 14V or less than 4.5V. To power the device from 3.3V, short ABP and DBP with  $V_{CC}$ .

### SMBus Address

The device has both a JTAG interface and SMBus serial interface. The SMBus slave address of the on-board device can be set using J3 according to Table 3. Note that this externally configured SMBus slave address can be overridden by device register r8Bh.

### On-Board MOSFETs and Potentiometers

To facilitate evaluation of the monitoring and control functions of the device, two potentiometers provide adjustable voltages. The potentiometers are connected to the device in series with n-channel MOSFETs that are controlled by two sequencing outputs of the device (Figure 13). This combination imitates two power supplies. Fault conditions can be simulated simply by adjusting the potentiometer according to the scale on the PCB silkscreen.

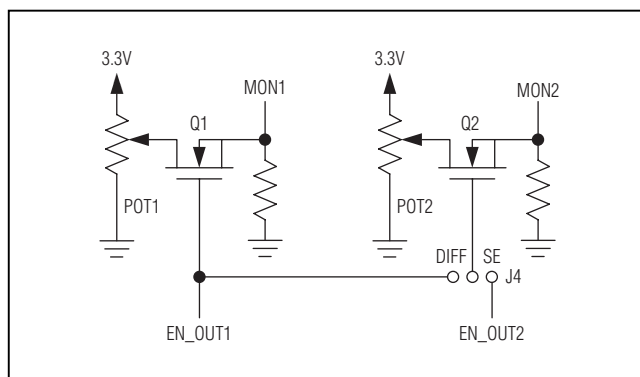

Figure 13. On-Board Series-Pass MOSFETs (Simplified Circuit)

To use the potentiometer assigned to MON1, make sure switch 1 in switch bank S1 is turned off (no loopback) and make sure switches 5 and 6 in switch bank S2 are turned on. This connects the potentiometer circuit to the device. For the MON2 potentiometer, turn off switch 2 in switch bank S1 and turn on switches 7 and 8 in switch bank S2.

### Single-Ended Mode

In single-ended mode (J4 is in the 1-2 position) the device monitors the voltages of each potentiometer separately. In the **Input/Output** tab (Figure 2), assign thresholds and sequencing slots to MON1 and MON2.

# MAX16065 Evaluation Kit

## Evaluates: MAX16065

Set EN\_OUT1 and EN\_OUT2 to the **Charge Pump** configurations, and assign them sequencing slots so that EN\_OUT1 is in the same slot as MON1 and EN\_OUT2 is in the same slot as MON2.

### Differential Mode

The potentiometers can be used to evaluate the differential input function of the device. In the **Input/Output** tab, set MON2 to **Differential** and assign thresholds and a sequencing slot. Set EN\_OUT1 to the same slot. Set jumper J4 (MON1-2 SE/DIFF) on the EV kit to the 2-3 position. This allows both potentiometers to be switched by the EN\_OUT1 output. Control the voltage on MON1 using POT1 and the voltage on MON2 using POT2. The device monitors the voltage difference of POT1 - POT2.

### Monitoring Inputs and Enable Outputs

Each of the MON\_ inputs and EN\_OUT\_ outputs can be accessed through headers P8 (EN\_OUT) and P6 (MON).

Switch banks S1 and S2 allow EN\_OUT1-EN\_OUT12 to be connected to MON1-MON12 to help evaluate the device's sequencing feature. Configure the EN\_OUT\_s for active-high push-pull, and the voltage thresholds of the MON\_s to correspond with the output logic levels.

### Precision Current Sense

The EV kit provides connections to the precision current-sense amplifier of the device. The positive input terminal (CSP) needs a bias voltage of 3V to 14V for proper operation. To use the VCC voltage selected by J1, short jumper J2. To provide an external bias voltage, disconnect J2 and connect the bias supply to pin 1 of header P6 (MON).

A high-accuracy voltage source can be connected between CSP and CSM (pins 1 and 2 of header P6) to evaluate the monitoring and fault functions of the current-sense amplifier. Alternatively, a current-sense resistor can be soldered into position R11 and a test current directed through CSP to CSM.

The voltage of CSP can be monitored using the EV kit software, although this monitoring function does not have fault thresholds and cannot trigger a fault.

### General-Purpose Inputs and Outputs

Each GPIO has a separate indicator LED and pullup resistor, and each signal is brought out to a pin on P7. An LED lights to indicate that the associated output has gone to the logic-low state. The LEDs can be disabled by turning off switch 8 in switch bank S4 (PC SEL). The pullup resistors are individually switched by S5 (see Table 4 for the assignments of each switch in the switch bank). To use an external pullup voltage, set switch 8 of switch bank S3 (EXT SEL) in the off position and connect

the voltage source to the VPU pin of P7. This pullup voltage is also used for the reset output's pullup resistor.

### Reset Output

LED5 displays the status of the reset output. When the reset output is low, the LED lights up. If switch 8 of switch bank S6 (FEATURE) is in the on position, a 10kΩ pullup resistor is connected to the reset output. Power to the LED is controlled by switch 8 of switch bank S4 (PC SEL), just as with the GPIO.

### Hardware Enables

The device has an analog EN connection that can be used to trigger power-up or power-down sequencing. An on-board resistive divider formed by R14 and R17 sets the falling threshold to 2.835V on VCC; the threshold can be modified by changing R14 and R17 according to the following formulas:

$$V_{VCC\_TH\_RISING} = 1.4 \cdot \left(1 + \frac{R14}{R17}\right)$$

$$V_{VCC\_TH\_FALLING} = 1.350 \cdot \left(1 + \frac{R14}{R17}\right)$$

EN can be manually controlled using the hardware enable switch (S9). Set S9 to the off position to pull EN to 0V, and set S9 to the on position to allow EN to respond to the VCC voltage.

To drive EN externally and disable the ENABLE switch, turn off switch 1 in switch bank S6 and connect the external circuit to pin 1 of header P7 (GPIO).

### Secondary Enable

For controlling the secondary sequence group, GPIO5 and GPIO7 can be configured as the secondary sequence enable (EN2) and wired to the ENABLE2 switch on the EV kit. After selecting the GPIO in the EV kit software's **Input/Output** tab (Figure 2), close switch 2 (if GPIO5 is to be used) or 3 (if GPIO7 is to be used) in switch bank S6.

### Manual Reset Button

A manual reset button (S7) is provided on the EV kit. It can be connected to GPIO1, GPIO3, GPIO5, or GPIO7. Close switch 4, 5, 6, or 7 in switch bank S6 to connect the manual reset button to a GPIO configured as the manual reset input. Configure the GPIOs using the EV kit software's **Input/Output** tab.

The manual reset button can also be used to evaluate the watchdog timer by connecting it to GPIO1 and configuring GPIO1 as the watchdog input (WDI). Push the button to pulse WDI and clear the watchdog timer. For best results, use long watchdog timeout periods.

# MAX16065 Evaluation Kit

## Evaluates: MAX16065

### Jumper Function Tables

**Table 2. Jumper Functions (J1, J2, J4, S1–S6)**

JUMPER	POSITION	FUNCTION
J1	5V	Device powered from the USB voltage.
	3.3V	Device powered from on-board 3.3V LDO.
	EXT	Device powered externally.
J2	Open	Biased externally (3V to 14V range).
	Closed*	Biased to V <sub>CC</sub> .
J4	1-2	Single-ended mode.
	2-3	Differential mode (POT1 and POT2 both controlled by EN_OUT1).
S1	1-8	Loopback control.
S2	1-4	Loopback control.
	5-6	Connects POT1 to MON1/EN_OUT1.
	7-8	Connects POT2 to MON2/EN_OUT2.
S3	1-3	SMBus connects to part.
	4-7	JTAG connects to part.
	8	GPIO pulled up to 3.3V when on.
S4	1-3	SMBus connects to host interface.
	4-7	JTAG connects to host interface.
	8	GPIO LED indicators on.
S5	1-8	Connects individual pullup resistors to GPIO.
S6	1	Connects ENABLE switch to EN pin.
	2-3	Connects secondary enable (EN2) switch to either GPIO5 or GPIO7.
	4-7	Connects manual reset switch (S7) to GPIO1, 3, 5, or 7.
	8	Connects pullup resistor to RESET output.

\*Default position.

**Table 3. Jumper Function (J3)**

SHUNT POSITION	SMBus SLAVE ADDRESS
Low*	1010 00XR (A0h)
High	1010 01XR (A4h)
SCL	1010 10XR (A8h)
SDA	1010 11XR (ACh)

\*Default position.

X = Don't care, R = Read/write select bit.

**Table 4. SMBus Connector Pinout (P5)**

PIN	FUNCTION
1	3.3V (output only)
2	SDA
3	Ground
4	SCL
5	SMBALERT# (not used by the device)

**Table 5. JTAG Connector Pinout (P4)**

PIN	FUNCTION
1	TCK
2	Ground
3	TDO
4	3.3V (output only)
5	TMS
6	—
7	— (key)
8	—
9	TDI
10	Ground

# MAX16065 Evaluation Kit

## Evaluates: MAX16065

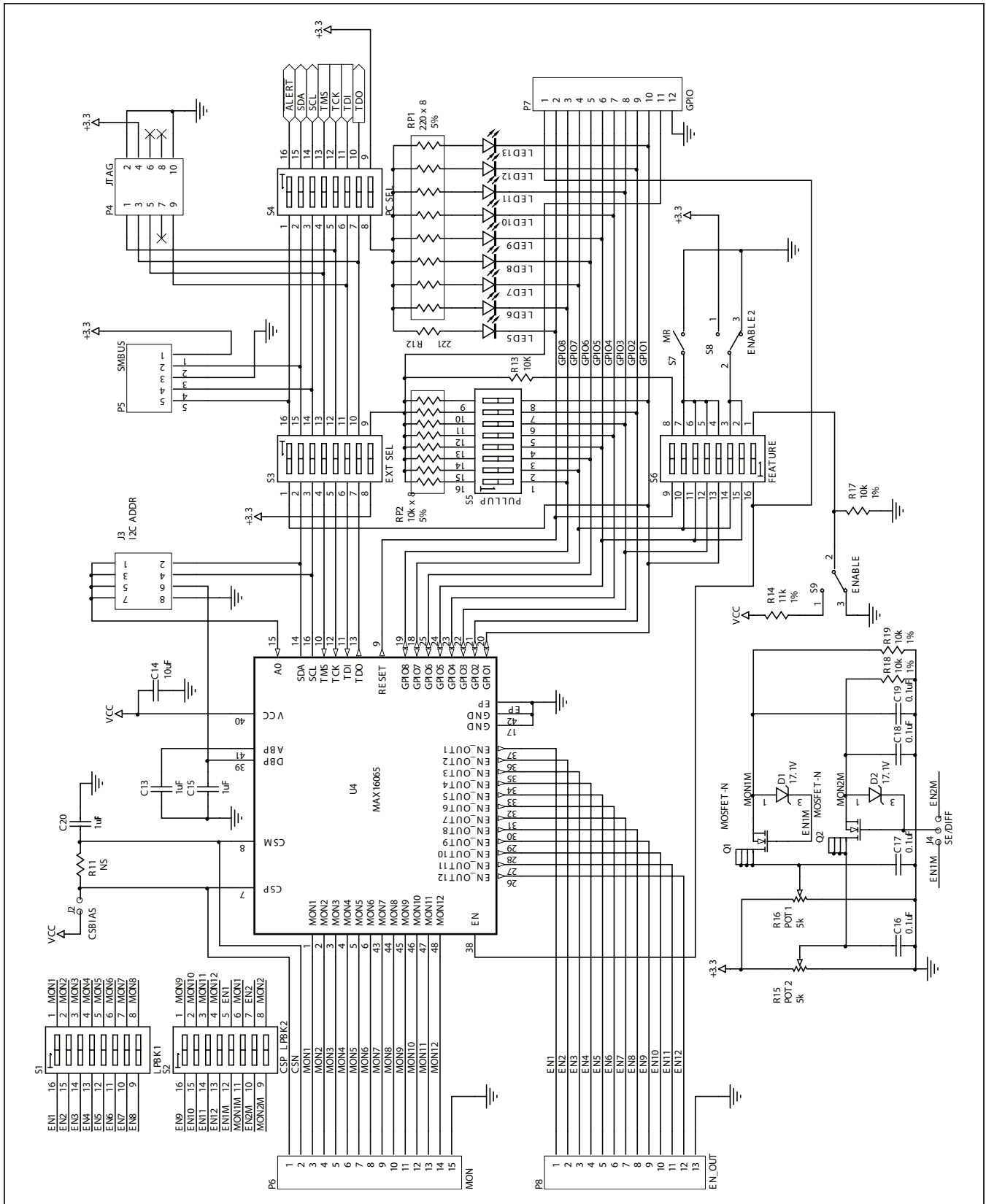

Figure 14. MAX16065EV Kit Schematic

# MAX16065 Evaluation Kit

## Evaluates: MAX16065

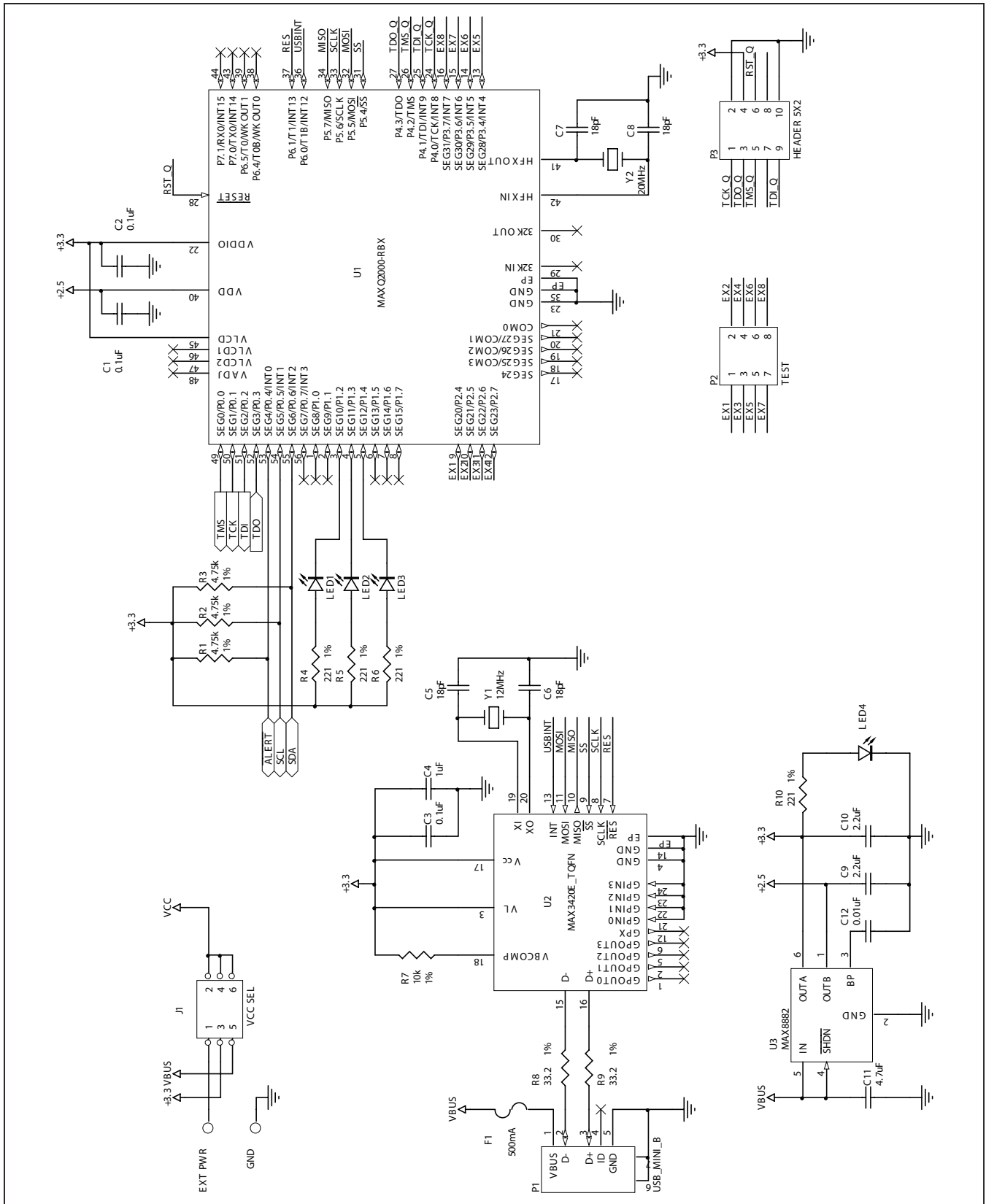

Figure 15. MAX16065EV Kit Schematic—USB Interface



# MAX16065 Evaluation Kit

## Evaluates: MAX16065

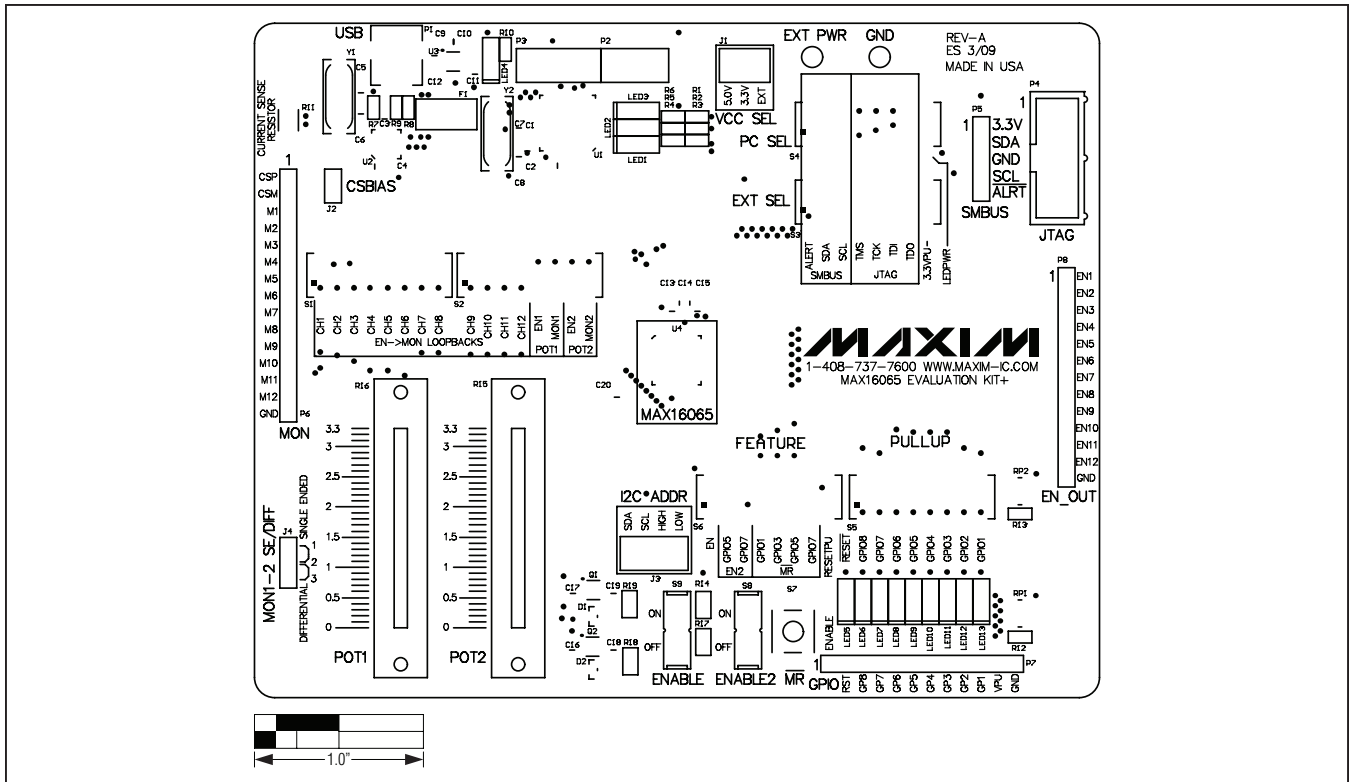

Figure 16. MAX16065EV Kit Component Placement Guide—Component Side

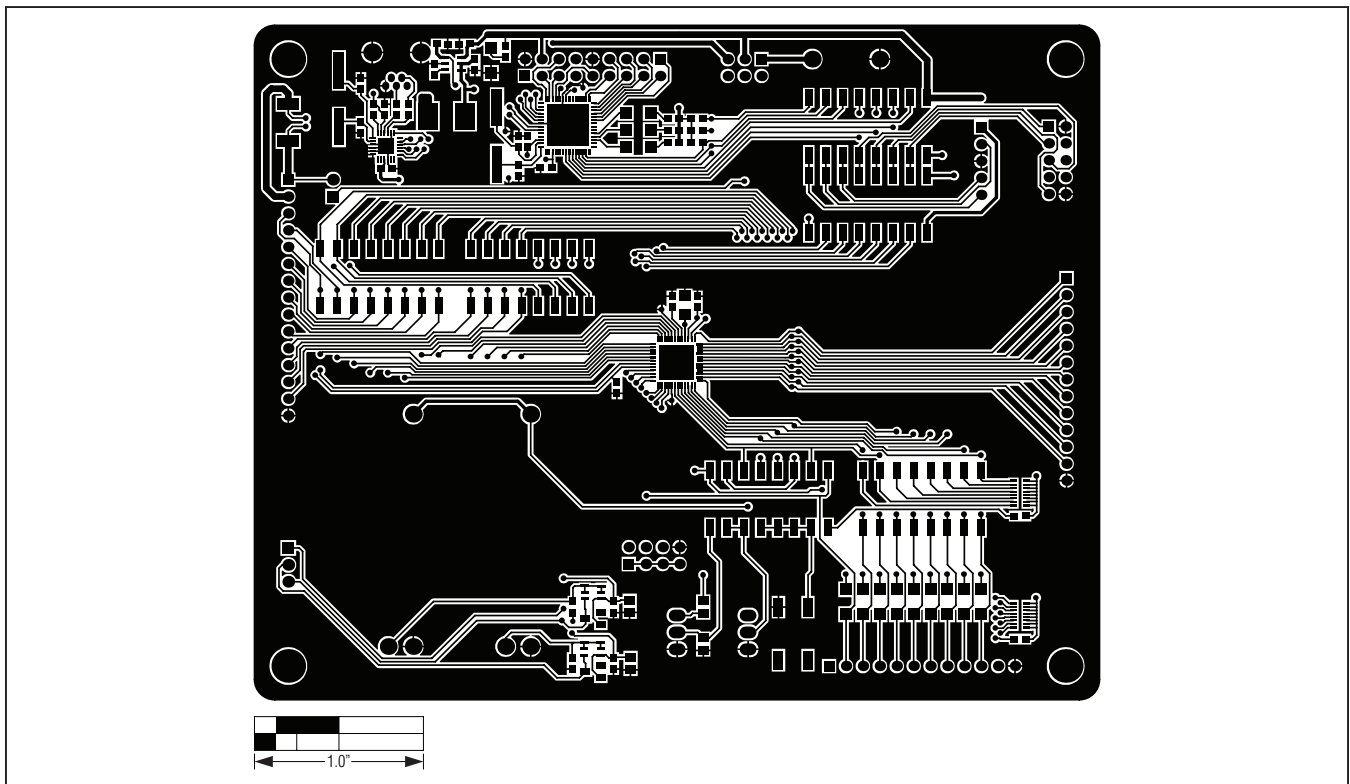

Figure 17. MAX16065EV Kit PCB Layout—Component Side

# MAX16065 Evaluation Kit

## Evaluates: MAX16065

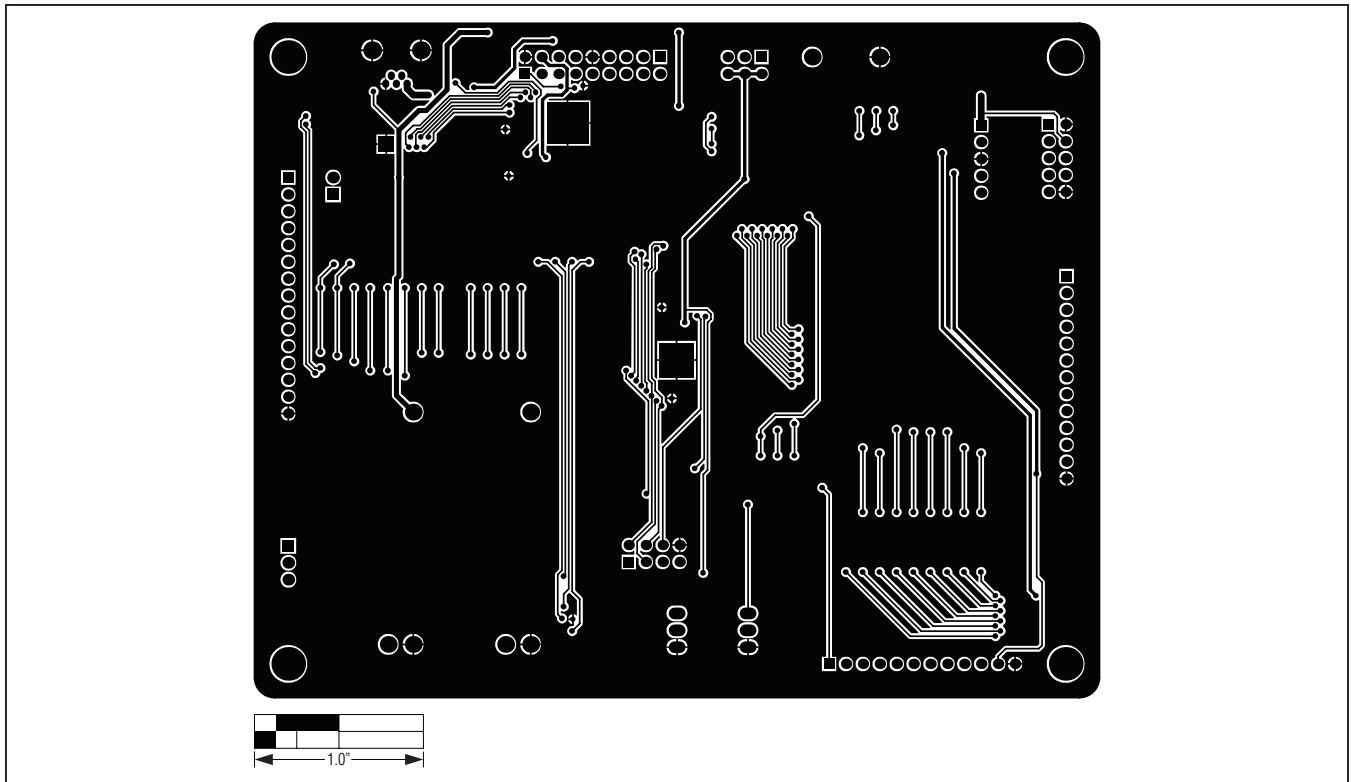

Figure 18. MAX16065EV Kit PCB Layout—Solder Side

# MAX16065 Evaluation Kit

## Evaluates: MAX16065

### ***Ordering Information***

<b>PART</b>	<b>TYPE</b>
MAX16065EVKIT+	EV Kit

+Denotes lead(Pb)-free and RoHS compliant.

# MAX16065 Evaluation Kit

## Evaluates: MAX16065

### *Revision History*

REVISION NUMBER	REVISION DATE	DESCRIPTION	PAGES CHANGED
0	5/11	Initial release	—

*Maxim cannot assume responsibility for use of any circuitry other than circuitry entirely embodied in a Maxim product. No circuit patent licenses are implied. Maxim reserves the right to change the circuitry and specifications without notice at any time.*

**Maxim Integrated Products, 120 San Gabriel Drive, Sunnyvale, CA 94086 408-737-7600 \_\_\_\_\_ 22**