

Power Schottky rectifier

Features

- High junction temperature capability
- Avalanche rated
- Low leakage current
- Good trade-off between leakage current and forward voltage drop

Description

Dual center tap Schottky rectifier suited for high frequency Switch Mode Power Supply.

Packaged in TO-220AB, TO-220AB narrow leads and I²PAK, this device is intended to be used in notebook and LCD adaptors, desktop SMPS, providing in these applications a margin between the remaining voltages applied on the diode and the voltage capability of the diode.

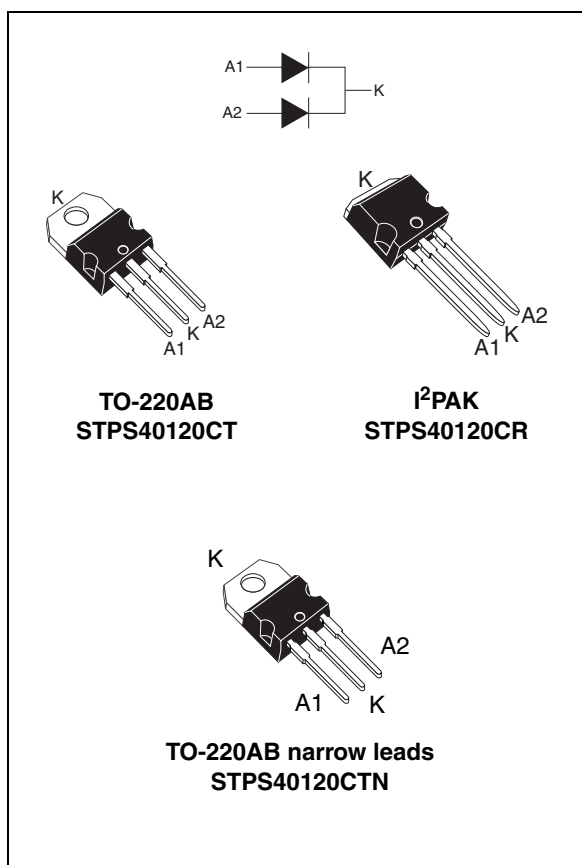

Table 1. Device summary

$I_{F(AV)}$	2 x 20 A
V_{RRM}	120 V
$T_{j(max)}$	175 °C
$V_{F(typ)}$	0.57 V

1 Characteristics

Table 2. Absolute ratings (limiting values, per diode)

Symbol	Parameter		Value	Unit	
V_{RRM}	Repetitive peak reverse voltage		120	V	
$I_{F(RMS)}$	Forward rms current		30	A	
$I_{F(AV)}$	Average forward current	$\delta = 0.5$	Per diode	20	A
		$T_c = 145\text{ °C}$	Per device	40	
I_{FSM}	Surge non repetitive forward current		$t_p = 10\text{ ms sinusoidal}$	200	A
P_{ARM}	Repetitive peak avalanche power		$t_p = 1\text{ }\mu\text{s}, T_j = 25\text{ °C}$	10500	W
T_{stg}	Storage temperature range		-65 to + 175	°C	
T_j	Maximum operating junction temperature ⁽¹⁾		175	°C	

1. $\frac{dP_{tot}}{dT_j} < \frac{1}{R_{th(j-a)}}$ condition to avoid runaway for a diode on its own heatsink

Table 3. Thermal parameters

Symbol	Parameter		Value	Unit
$R_{th(j-c)}$	Junction to case	Per diode	1.6	°C/W
		Total	0.85	
$R_{th(c)}$	Coupling	Total	0.1	°C/W

When the diodes 1 and 2 are used simultaneously:

$$\Delta T_j(\text{diode 1}) = P(\text{diode 1}) \times R_{th(j-c)}(\text{per diode}) + P(\text{diode 2}) \times R_{th(c)}$$

Table 4. Static electrical characteristics (per diode)

Symbol	Test conditions			Min.	Typ.	Max.	Unit
$I_R^{(1)}$	Reverse leakage current	$T_j = 25\text{ °C}$	$V_R = V_{RRM}$			25	μA
		$T_j = 125\text{ °C}$			4	12	mA
$V_F^{(2)}$	Forward voltage drop	$T_j = 25\text{ °C}$	$I_F = 7.5\text{ A}$			0.73	V
		$T_j = 125\text{ °C}$			0.57	0.61	
		$T_j = 25\text{ °C}$	$I_F = 20\text{ A}$			0.9	
		$T_j = 125\text{ °C}$			0.69	0.73	
		$T_j = 25\text{ °C}$	$I_F = 40\text{ A}$			1	
		$T_j = 125\text{ °C}$			0.83	0.88	

1. Pulse test: $t_p = 5\text{ ms}, \delta < 2\%$

2. Pulse test: $t_p = 380\text{ }\mu\text{s}, \delta < 2\%$

To evaluate the maximum conduction losses use the following equation:

$$P = 0.58 \times I_{F(AV)} + 0.0075 I_{F(RMS)}^2$$

Figure 1. Average forward power dissipation versus average forward current (per diode)

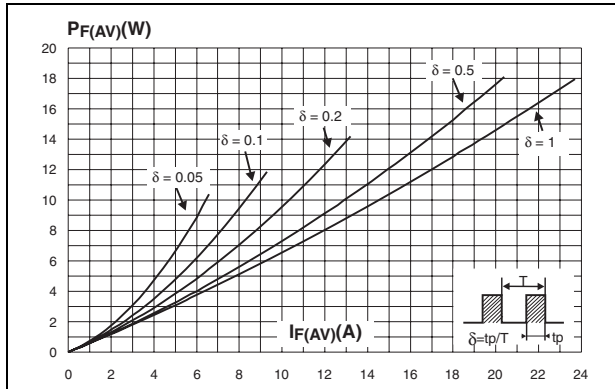

Figure 2. Average forward current versus ambient temperature ($\delta = 0.5$, per diode)

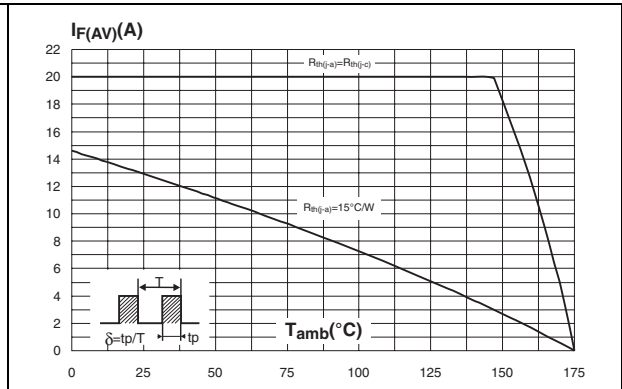

Figure 3. Normalized avalanche power derating versus pulse duration

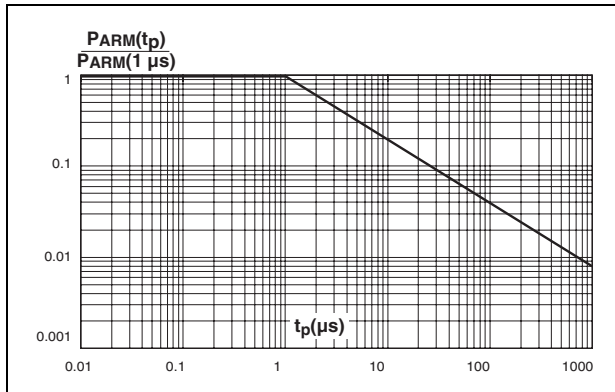

Figure 4. Normalized avalanche power derating versus junction temperature

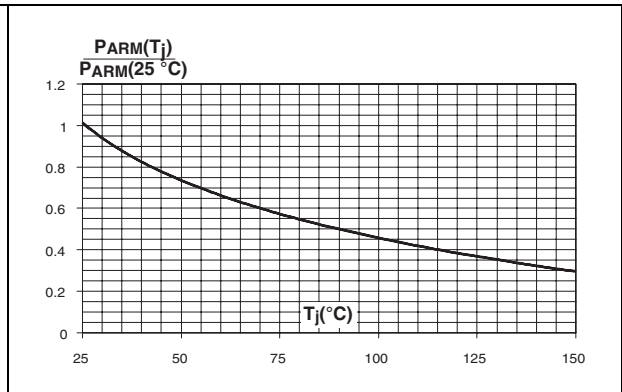

Figure 5. Non repetitive surge peak forward current versus overload duration (maximum values, per diode)

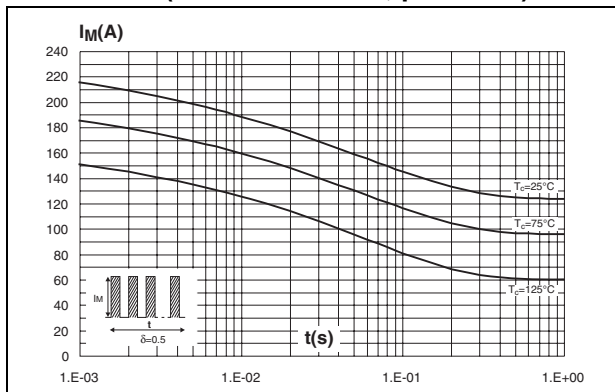

Figure 6. Relative variation of thermal impedance junction to ambient versus pulse duration

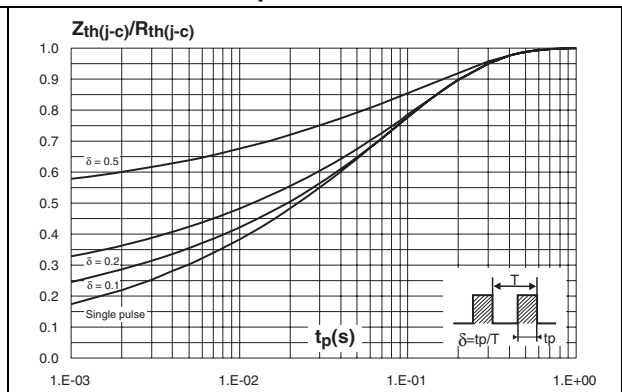

Figure 7. Reverse leakage current versus reverse voltage applied (typical values, per diode)

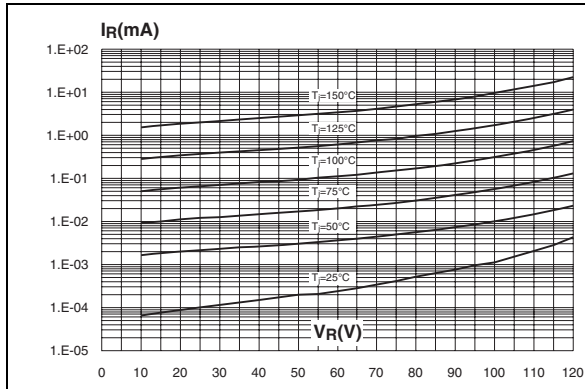

Figure 8. Junction capacitance versus reverse voltage applied (typical values, per diode)

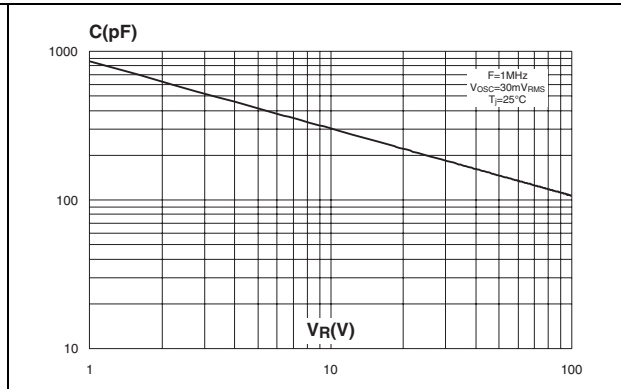
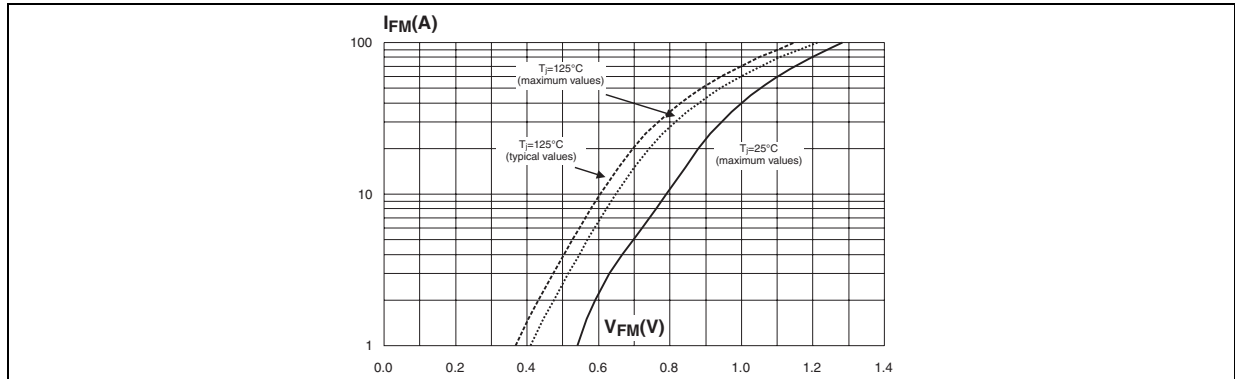

Figure 9. Forward voltage drop versus forward current (per diode)



2 Package information

- Epoxy meets UL94, V0
- Cooling method: by conduction (C)
- Recommended torque value: 0.4 to 0.6 N·m

In order to meet environmental requirements, ST offers these devices in different grades of ECOPACK® packages, depending on their level of environmental compliance. ECOPACK® specifications, grade definitions and product status are available at: www.st.com. ECOPACK® is an ST trademark.

Figure 10. TO-220AB dimensions

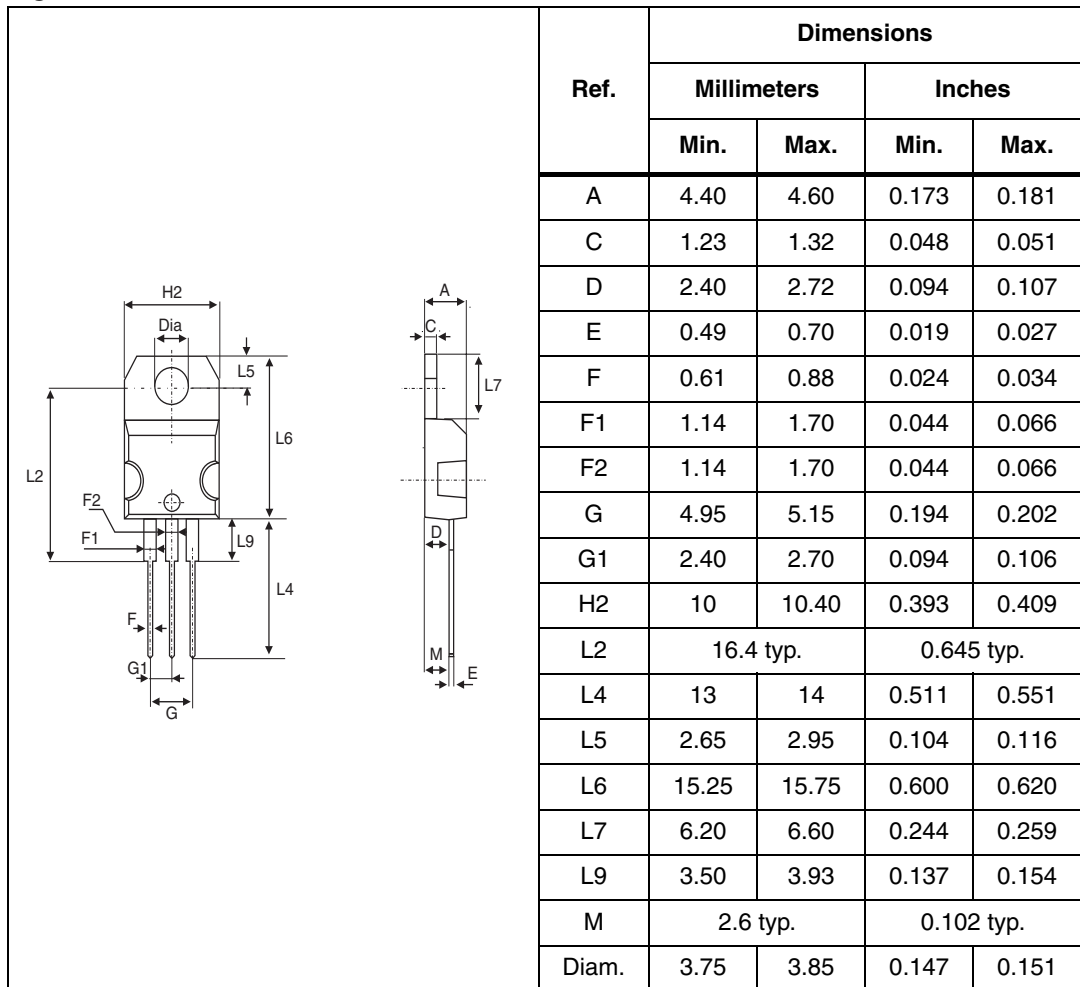
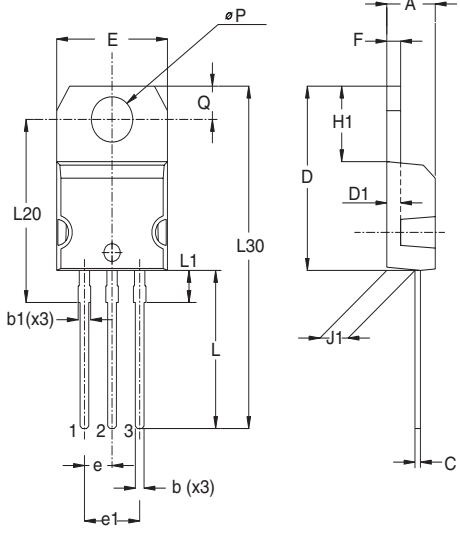

Table 5. TO-220AB narrow leads dimensions

Ref.	Dimensions					
	Millimeters			Inches		
	Min.	Typ.	Max.	Min.	Typ.	Max.
A	4.40		4.60	0.17		0.18
b	0.61		0.88	0.024		0.034
b1	0.95		1.20	0.037		0.047
c	0.48		0.70	0.019		0.027
D	15.25		15.75	0.60		0.62
D1	1.27			0.05		
E	10.00		10.40	0.39		0.41
e	2.40		2.70	0.094		0.106
e1	4.95		5.15	0.19		0.20
F	1.23		1.32	0.048		0.052
H1	6.20		6.60	0.24		0.26
J1	2.40		2.72	0.095		0.107
L	13.00		14.00	0.51		0.55
L1	2.60		2.90	0.102		0.114
L20	15.40			0.61		
L30	28.90			1.14		
ØP	3.75		3.85	0.147		0.151
Q	2.65		2.95	0.104		0.116



Devices in I²PAK with nickel-plated back frame must NOT be mounted by frame soldering like SMDs. Such devices are intended to be through-hole mounted ONLY and in no circumstances shall ST be held liable for any lack of performance or damage arising out of soldering of nickel-plated back frames.

Table 6. I²PAK dimensions

Ref.	Dimensions			
	Millimeters		Inches	
	Min.	Max.	Min.	Max.
A	4.40	4.60	0.173	0.181
A1	2.40	2.72	0.094	0.107
b	0.61	0.88	0.024	0.035
b1	1.14	1.70	0.044	0.067
c	0.49	0.70	0.019	0.028
c2	1.23	1.32	0.048	0.052
D	8.95	9.35	0.352	0.368
e	2.40	2.70	0.094	0.106
e1	4.95	5.15	0.195	0.203
E	10	10.40	0.394	0.409
L	13	14	0.512	0.551
L1	3.50	3.93	0.138	0.155
L2	1.27	1.40	0.050	0.055

3 Ordering information

Table 7. Ordering information

Order code	Marking	Package	Weight	Base qty	Delivery mode
STPS40120CT	STPS40120CT	TO-220AB	2.2 g	50	Tube
STPS40120CR	STPS40120CR	I ² PAK	1.49 g	50	Tube
STPS40120CTN	PS40120CTN	TO-220AB narrow leads	1.9 g	50	Tube

4 Revision history

Table 8. Document revision history

Date	Revision	Changes
18-Feb-2005	1	First issue
1-Dec-2006	2	Reformatted to current standards. Added I ² PAK.
15-Sep-2011	3	Added TO-220AB narrow leads package.

Please Read Carefully:

Information in this document is provided solely in connection with ST products. STMicroelectronics NV and its subsidiaries ("ST") reserve the right to make changes, corrections, modifications or improvements, to this document, and the products and services described herein at any time, without notice.

All ST products are sold pursuant to ST's terms and conditions of sale.

Purchasers are solely responsible for the choice, selection and use of the ST products and services described herein, and ST assumes no liability whatsoever relating to the choice, selection or use of the ST products and services described herein.

No license, express or implied, by estoppel or otherwise, to any intellectual property rights is granted under this document. If any part of this document refers to any third party products or services it shall not be deemed a license grant by ST for the use of such third party products or services, or any intellectual property contained therein or considered as a warranty covering the use in any manner whatsoever of such third party products or services or any intellectual property contained therein.

UNLESS OTHERWISE SET FORTH IN ST'S TERMS AND CONDITIONS OF SALE ST DISCLAIMS ANY EXPRESS OR IMPLIED WARRANTY WITH RESPECT TO THE USE AND/OR SALE OF ST PRODUCTS INCLUDING WITHOUT LIMITATION IMPLIED WARRANTIES OF MERCHANTABILITY, FITNESS FOR A PARTICULAR PURPOSE (AND THEIR EQUIVALENTS UNDER THE LAWS OF ANY JURISDICTION), OR INFRINGEMENT OF ANY PATENT, COPYRIGHT OR OTHER INTELLECTUAL PROPERTY RIGHT.

UNLESS EXPRESSLY APPROVED IN WRITING BY TWO AUTHORIZED ST REPRESENTATIVES, ST PRODUCTS ARE NOT RECOMMENDED, AUTHORIZED OR WARRANTED FOR USE IN MILITARY, AIR CRAFT, SPACE, LIFE SAVING, OR LIFE SUSTAINING APPLICATIONS, NOR IN PRODUCTS OR SYSTEMS WHERE FAILURE OR MALFUNCTION MAY RESULT IN PERSONAL INJURY, DEATH, OR SEVERE PROPERTY OR ENVIRONMENTAL DAMAGE. ST PRODUCTS WHICH ARE NOT SPECIFIED AS "AUTOMOTIVE GRADE" MAY ONLY BE USED IN AUTOMOTIVE APPLICATIONS AT USER'S OWN RISK.

Resale of ST products with provisions different from the statements and/or technical features set forth in this document shall immediately void any warranty granted by ST for the ST product or service described herein and shall not create or extend in any manner whatsoever, any liability of ST.

ST and the ST logo are trademarks or registered trademarks of ST in various countries.

Information in this document supersedes and replaces all information previously supplied.

The ST logo is a registered trademark of STMicroelectronics. All other names are the property of their respective owners.

© 2011 STMicroelectronics - All rights reserved

STMicroelectronics group of companies

Australia - Belgium - Brazil - Canada - China - Czech Republic - Finland - France - Germany - Hong Kong - India - Israel - Italy - Japan - Malaysia - Malta - Morocco - Philippines - Singapore - Spain - Sweden - Switzerland - United Kingdom - United States of America

www.st.com