

# DATA SHEET

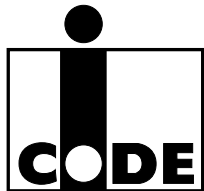

## **SLEV900** I-CODE Evaluation kit

Product specification  
Supersedes data of 2000 Feb 01

2002 May 23

**I-CODE Evaluation kit****SLEV900**

<b>CONTENTS</b>			
1	FEATURES	7.4	Write
2	APPLICATIONS	7.5	Read EAS
3	GENERAL DESCRIPTION	7.6	Activate EAS
4	ORDERING INFORMATION	7.7	Deactivate EAS
5	BLOCK DIAGRAM	7.8	EAS command
6	FUNCTIONAL DESCRIPTION	7.9	Memory content
6.1	Hardware	8	RELATED INFORMATION
6.2	Software	8.1	Additional documents
6.2.1	System requirements	8.2	Training
6.2.2	Contents of disks	8.3	Support hot-line
6.2.3	Software installation	9	DATA SHEET STATUS
6.2.4	Restrictions of Windows I-CODE demo software	10	DEFINITIONS
7	SOFTWARE DESCRIPTION	11	DISCLAIMERS
7.1	Main screen		
7.2	Read serial numbers		
7.3	Read		

## I-CODE Evaluation kit

SLEV900

**1 FEATURES**

The evaluation kit comprises the following components:

- I-CODE<sup>(1)</sup> read/write device
- I-CODE antenna
- Power supply cable 24 V
- PC serial interface cable
- Ten I-CODE labels respectively inlets
- Three disks with:
  - Demonstration software
  - Evaluation software
  - Source code.
- I-CODE evaluation kit user manual
- Interface protocol reader host description.

**2 APPLICATIONS**

- Easy plug and play demonstration of I-CODE functionality
- Fast implementation of small applications and feasibility studies.

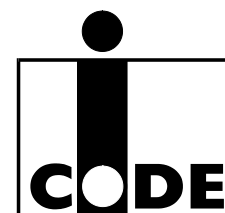
**3 GENERAL DESCRIPTION**

The I-CODE evaluation kit offers a tool, which was designed for two major purposes:

- Easy plug and play demonstration of I-CODE functionality (with the use of the windows demo software)
- Fast implementation of small applications and feasibility studies (using the interface protocol description and the C-software library). In addition the attached DOS based evaluation software offers an easy possibility to evaluate all commands, within the command set of the I-CODE label IC. Moreover application specific configurations of the demo reader may be performed with this software.

Since Philips Semiconductors is mainly focused on the label IC, Philips does not produce complete inlets or labels. Nevertheless we have attached labels and inlets of manufacturers that already incorporated I-CODE in their standard product range.

For detailed information on the I-CODE1 label IC functionality encompassing the description of the memory organisation, the serial number, write access conditions special functions and family code, please refer to data sheet "SL1ICS3001 I-CODE1 Label IC".

(1) I-CODE - is a trademark of Koninklijke Philips Electronics N.V.

**4 ORDERING INFORMATION**

TYPE NUMBER	NAME	ORDER CODE (12NC)
SLEV900/AFB	I-CODE Evaluation kit	9352 623 26122

## I-CODE Evaluation kit

## SLEV900

## 5 BLOCK DIAGRAM

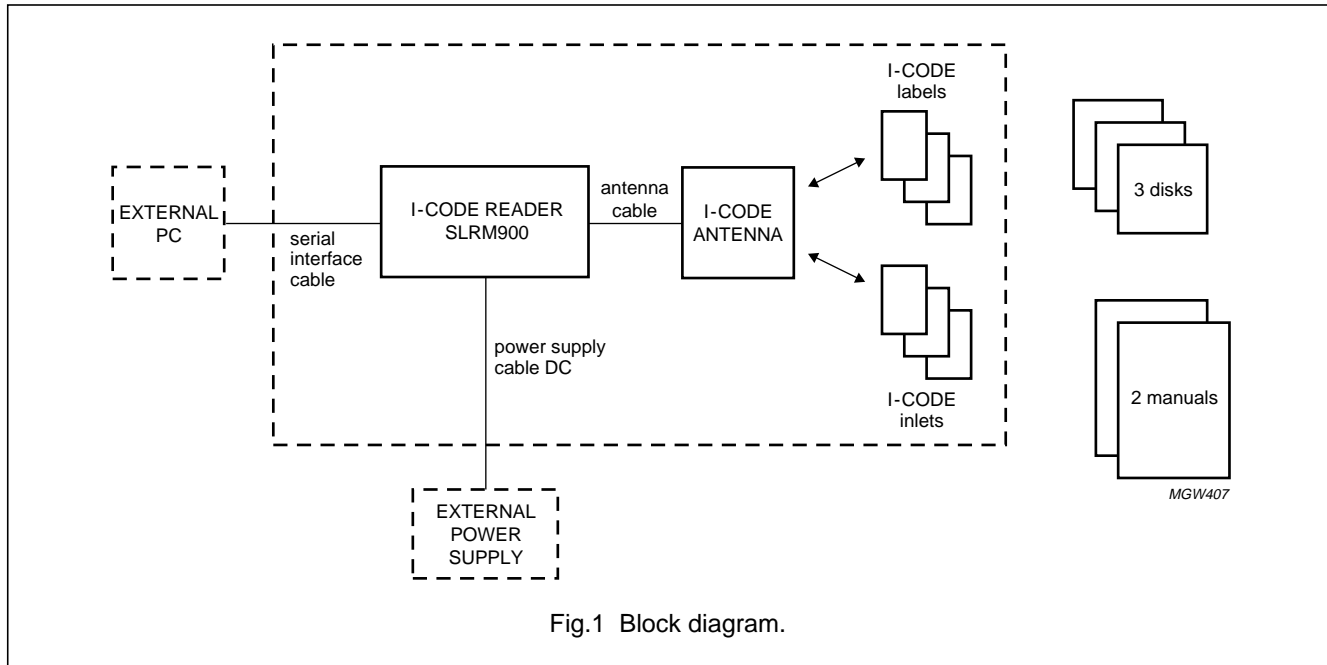

Fig.1 Block diagram.

## 6 FUNCTIONAL DESCRIPTION

## 6.1 Hardware

Getting started with the I-CODE evaluation kit requires the following steps:

1. Connect the antenna cable to the BNC connector at the I-CODE reader
2. Connect the serial interface cable to the COM1 or COM2 port at your host PC and to the connector at the I-CODE reader
3. Connect the 24 V power supply cable to the appropriate connector at the I-CODE reader and to a  $24 \pm 1$  V, 40 W power supply
4. Connect the 24 V power supply to the mains and switch it on.

The I-CODE reader is now ready for use.

**Remark:** The I-CODE evaluation kit is delivered with an RF power output of 4 W. Since the evaluation kit antenna was designed for that output power level, an RF power higher than 4 W might damage the evaluation kit antenna

If higher RF power is desired a customized antenna has to be used (e.g. gate antennas).

The RF power output is adjustable by software (e.g. with CRMTEST3.EXE).

## 6.2 Software

## 6.2.1 SYSTEM REQUIREMENTS

Minimum requirements of external PC:

- Pentium 133 MHz; 32 Mb RAM
- UART 16 550A (or compatible)
- 5 Mb free disk space
- Floppy disk drive 3.5 inch
- Resolution of the video-card and monitor:
  - $800 \times 600$  with small fonts or
  - $1024 \times 768$  with large fonts.
- Colour depth:
  - 16-bit (65536).

I-CODE Evaluation kit

SLEV900

6.2.2 CONTENTS OF DISKS

DISK	PROGRAM	DESCRIPTION
Disk 1	SETUP.EXE	installation program of WIN demo ICODE.EXE
Disk 2	SETUP.W02	second part of installation program
Disk 3	DOS_SW3.ZIP	DOS demo CRMTEST3.EXE
	VC6SOURCE.ZIP	visual C++ 6.0 source codes of WIN demo ICODE.EXE

The serial PC library crm\_s32.dll is not part of the SLEV900, but is supplied by Philips as a design tool that is free of charge and without any warranties.

6.2.3 SOFTWARE INSTALLATION

The I-CODE demonstration software works with Windows 95, Windows 98, and Windows NT 4.0.

Insert disk 1, start the SETUP.EXE program and follow the instructions.

If you want to change the COM port after the software installation, open the file ICODE.INI, in the directory where you have installed the software, with a text editor and modify the line COM = COMx (x = 1 or 2).

The baud rate of the reader is set to 57.6 kbaud as default.

6.2.4 RESTRICTIONS OF WINDOWS I-CODE DEMO SOFTWARE

The Windows Demo Software of the I-code Evaluation Kit does not allow the changing of Block 2 (Write Access Conditions) and of the QUIET bits in Block 3. The use of Family Codes and/or Application Identifiers is not supported.

7 SOFTWARE DESCRIPTION

The demonstration software shows the basic features of the I-CODE system. To start the program double click the I-CODE demo icon.

7.1 Main screen

The main screen allows the user to set up some parameters (see Table 1) and to start all supported commands; see the buttons in the dialogue box shown in Fig.2.

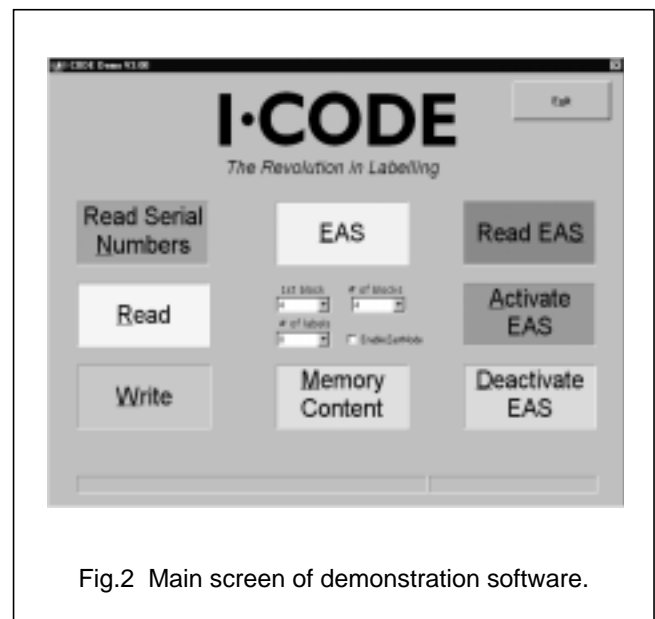

Fig.2 Main screen of demonstration software.

Table 1 Parameters in the main screen of the demonstration software

PARAMETER	DESCRIPTION	EXAMPLE
1st block	first block in the user memory with which you want to start the access; the first block in the user memory is block 4	4
# of blocks	number of blocks starting with the 1st block you want to access	4
# of labels	maximum number of labels that will be in the antenna field	8
Enable FastMode	if you click at this button the I-CODE reader works in fast mode	

To start a command click the corresponding button in the dialogue box or press the Alt-key and the underlined character. To exit a command, first click the Stop-button and then the Exit-button.

# I-CODE Evaluation kit

# SLEV900

## 7.2 Read serial numbers

This command reads the unique serial numbers (2 blocks = 8 bytes, least significant byte first) of the labels in the antenna field (see Fig.3). Each additional label which enters the field is added to the list. To clear the list click on the Stop-button and then the Once again-button.

The status line shows information about the number of detected labels.

The two arrow buttons on the right side of the screen can be used (after clicking the Stop-button) to scroll the content of the screen.

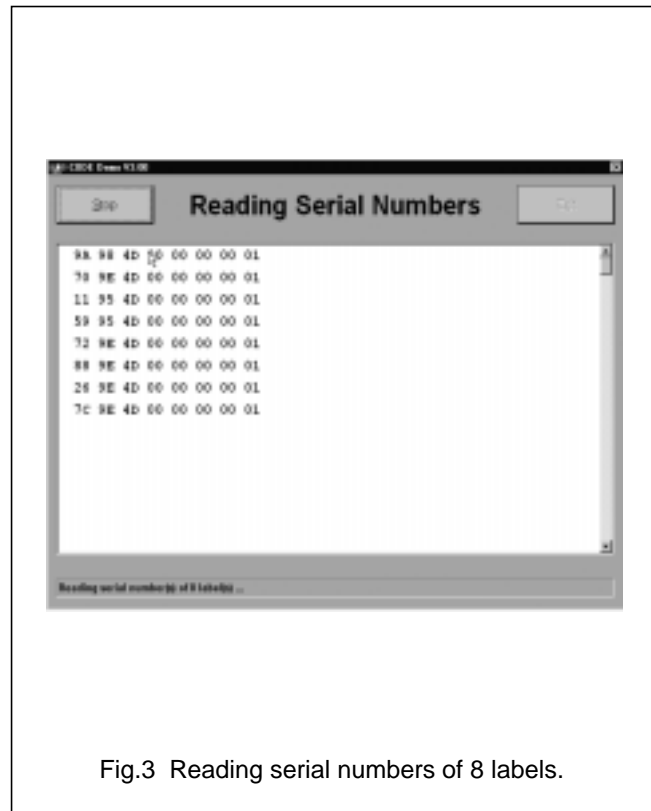

Fig.3 Reading serial numbers of 8 labels.

## 7.3 Read

After the button Read in the main menu is clicked, Fig.4 appears. With this command you will get the unique serial numbers and the content of read labels including the user memory. The first block and the number of blocks depend on the set-up in the main menu.

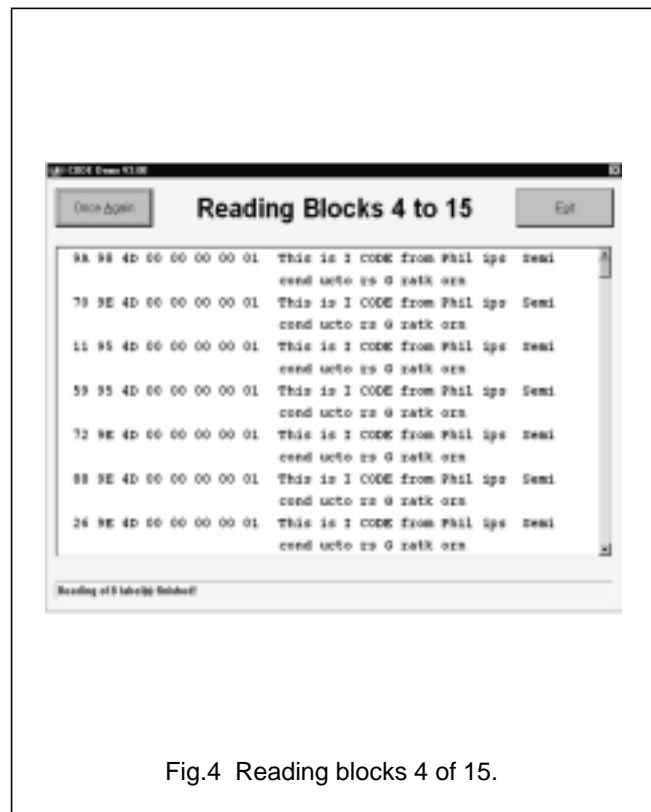

Fig.4 Reading blocks 4 of 15.

I-CODE Evaluation kit

SLEV900

7.4 Write

After selecting this command you can input your new data in the status line (see Fig.5). The length depends on the selected number of blocks.



Fig.5 Write blocks.

By clicking on the OK-button or pressing the Alt and o keys together, the selector box will appear (see Fig.6). You can select none, some or all of previously read labels by clicking on the corresponding item. Only the labels with selected serial numbers will be written to with the new data by clicking the OK-button.

The button Next label and the button Select are displayed from version 3.02 and further.

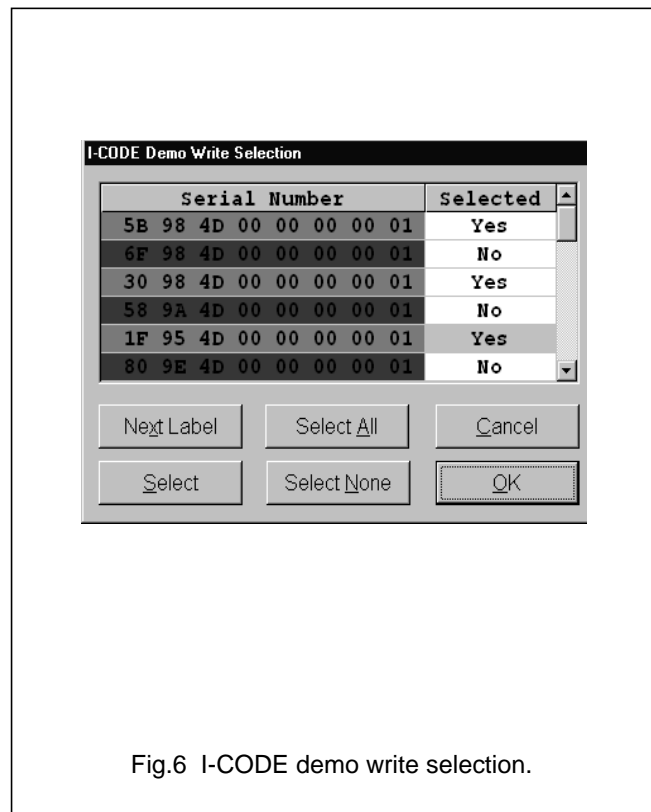

Fig.6 I-CODE demo write selection.

I-CODE Evaluation kit

SLEV900

After clicking the OK-button in Fig.6 the screen Fig.7 will appear.

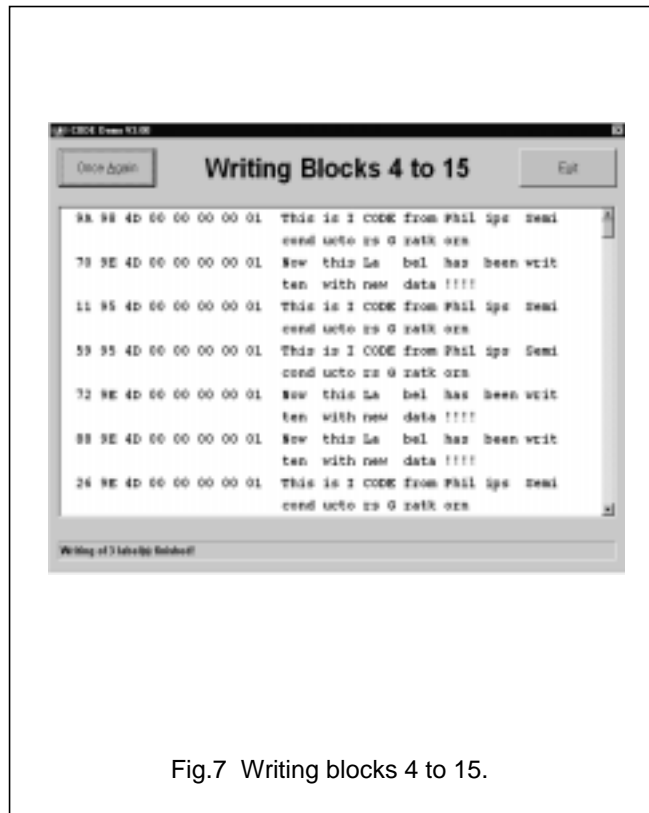

Fig.7 Writing blocks 4 to 15.

**7.5 Read EAS**

This command shows the unique serial numbers and the Electronic Article Surveillance (EAS) status of all the detected labels (see Fig.8).

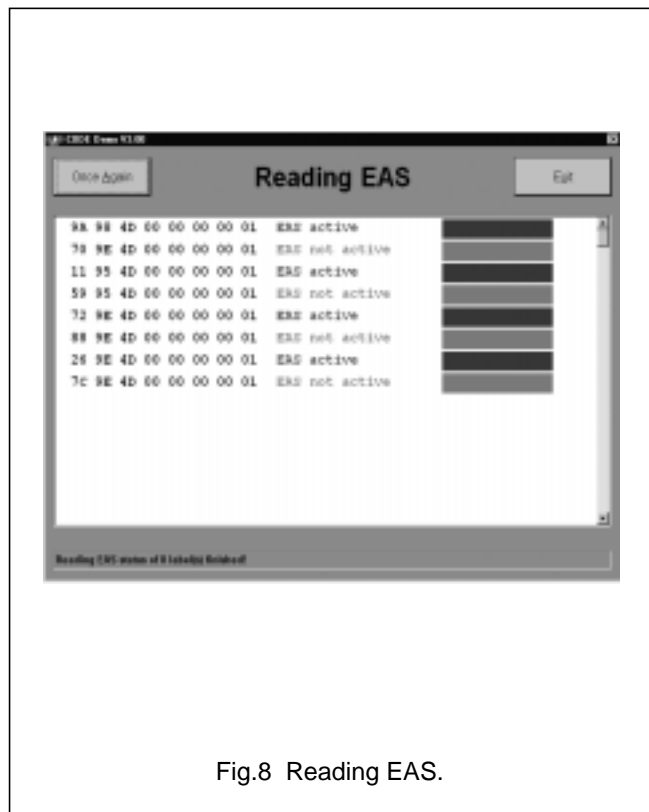

Fig.8 Reading EAS.



# I-CODE Evaluation kit

# SLEV900

## 7.6 Activate EAS

This command activates the EAS function of none, some or all of the previously read labels (see Fig.9). A selector box as described at the write command is used to select the concerned labels. The background colour of the serial numbers in the selector box shows the actual EAS status of the labels.

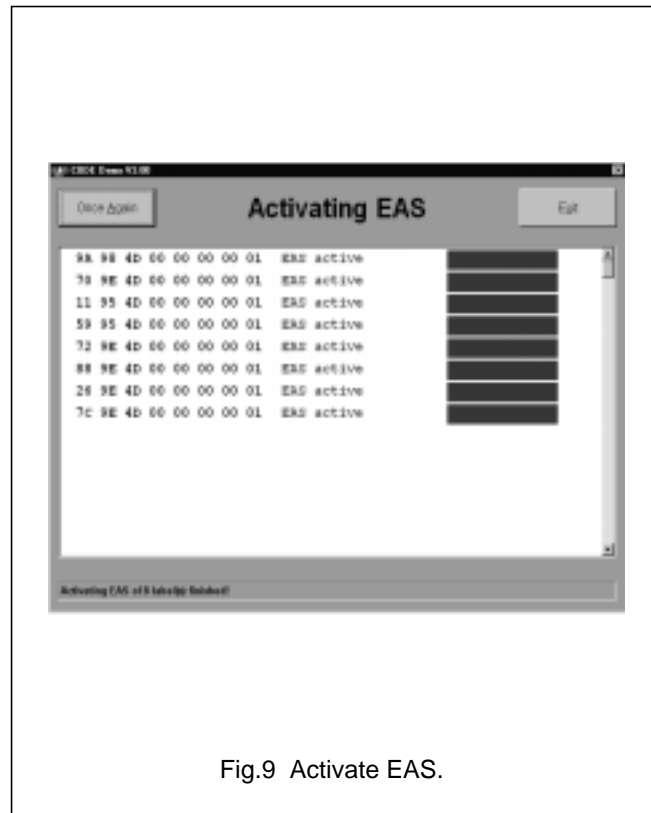

Fig.9 Activate EAS.

## 7.7 Deactivate EAS

This command deactivates the EAS function of none, some or all of the previously read labels (see Fig.10). A selector box as described at the write command is used to select the concerned labels. The background colour of the serial numbers in the selector box shows the actual EAS status of the labels.

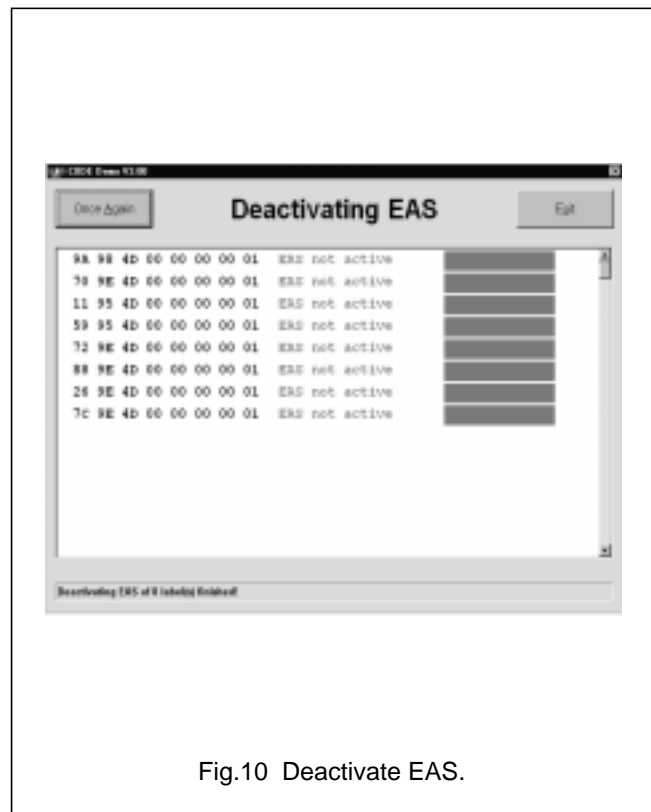

Fig.10 Deactivate EAS.

## I-CODE Evaluation kit

## SLEV900

**7.8 EAS command**

The following screen is shown if the EAS-button is clicked on the main screen (see Fig.11).



Fig.11 Electronic article surveillance.

The screen (see Fig.12) changes to the following if at least one label with activated EAS bits is found in the antenna field.



Fig.12 Electronic article surveillance.

I-CODE Evaluation kit

SLEV900

7.9 Memory content

As a result of this command you get the complete memory content of all detected labels (see Fig.13).

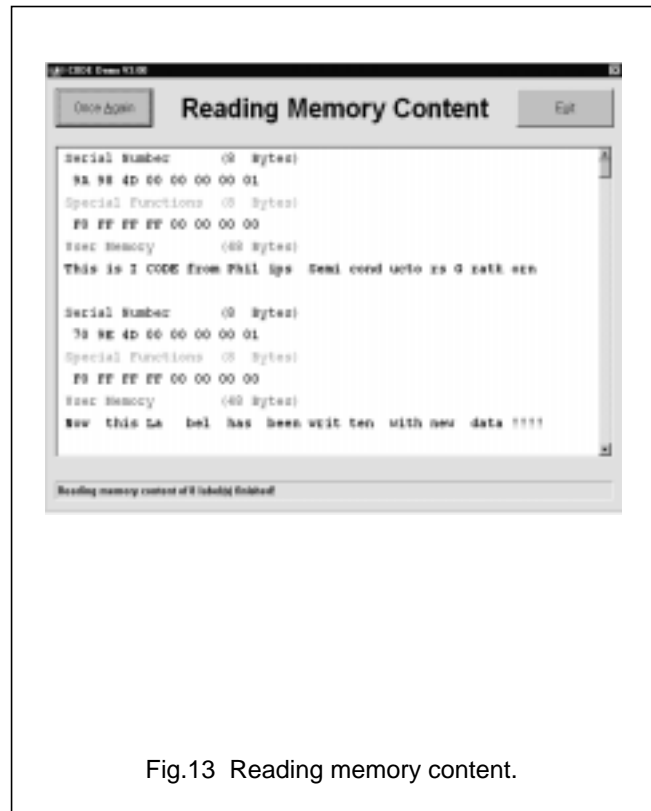

Fig.13 Reading memory content.

Table 2 Memory content

BLOCK NUMBER	CONTENT
0 to 1	unique serial number (8 bytes)
2 to 3	special function blocks for write access and EAS/QUIET (8 bytes)
4 to 15	user memory (48 bytes)

8 RELATED INFORMATION

8.1 Additional documents

Additional information concerning long range antennas and the functionality of the label IC is available in the following documents:

- Data sheet: "SL1ICS3001 I-CODE1 Label IC"
- Data sheet: "SL1ICS3001 I-CODE1 Label IC; protocol air interface"
- Application note: "I-CODE design of Read/Write antenna".

In order to receive the additional documents, please contact Philips Semiconductors Gratkorn Austria.

8.2 Training

It is strongly recommend to attend our I-CODE system and antenna training, which takes place on a regular basis at Philips Semiconductors Gratkorn Austria. The training provides background information and example antenna design, far beyond the information included in the available documents.

Please contact us for registration and further information.

8.3 Support hot-line

In case of further questions concerning the evaluation kit, please feel free to contact us on the Internet at URL <http://www.semiconductors.philips.com>.

## I-CODE Evaluation kit

## SLEV900

## 9 DATA SHEET STATUS

DATA SHEET STATUS <sup>(1)</sup>	PRODUCT STATUS <sup>(2)</sup>	DEFINITIONS
Objective data	Development	This data sheet contains data from the objective specification for product development. Philips Semiconductors reserves the right to change the specification in any manner without notice.
Preliminary data	Qualification	This data sheet contains data from the preliminary specification. Supplementary data will be published at a later date. Philips Semiconductors reserves the right to change the specification without notice, in order to improve the design and supply the best possible product.
Product data	Production	This data sheet contains data from the product specification. Philips Semiconductors reserves the right to make changes at any time in order to improve the design, manufacturing and supply. Changes will be communicated according to the Customer Product/Process Change Notification (CPCN) procedure SNW-SQ-650A.

## Notes

1. Please consult the most recently issued data sheet before initiating or completing a design.
2. The product status of the device(s) described in this data sheet may have changed since this data sheet was published. The latest information is available on the Internet at URL <http://www.semiconductors.philips.com>.

## 10 DEFINITIONS

**Short-form specification** — The data in a short-form specification is extracted from a full data sheet with the same type number and title. For detailed information see the relevant data sheet or data handbook.

**Limiting values definition** — Limiting values given are in accordance with the Absolute Maximum Rating System (IEC 60134). Stress above one or more of the limiting values may cause permanent damage to the device. These are stress ratings only and operation of the device at these or at any other conditions above those given in the Characteristics sections of the specification is not implied. Exposure to limiting values for extended periods may affect device reliability.

**Application information** — Applications that are described herein for any of these products are for illustrative purposes only. Philips Semiconductors make no representation or warranty that such applications will be suitable for the specified use without further testing or modification.

## 11 DISCLAIMERS

**Life support applications** — These products are not designed for use in life support appliances, devices, or systems where malfunction of these products can reasonably be expected to result in personal injury. Philips Semiconductors customers using or selling these products for use in such applications do so at their own risk and agree to fully indemnify Philips Semiconductors for any damages resulting from such application.

**Right to make changes** — Philips Semiconductors reserves the right to make changes, without notice, in the products, including circuits, standard cells, and/or software, described or contained herein in order to improve design and/or performance. Philips Semiconductors assumes no responsibility or liability for the use of any of these products, conveys no licence or title under any patent, copyright, or mask work right to these products, and makes no representations or warranties that these products are free from patent, copyright, or mask work right infringement, unless otherwise specified.

I-CODE Evaluation kit

SLEV900

---

**NOTES**

I-CODE Evaluation kit

SLEV900

---

**NOTES**

I-CODE Evaluation kit

SLEV900

---

**NOTES**

# *Philips Semiconductors – a worldwide company*

## **Contact information**

For additional information please visit <http://www.semiconductors.philips.com>. Fax: +31 40 27 24825

For sales offices addresses send e-mail to: [sales.addresses@www.semiconductors.philips.com](mailto:sales.addresses@www.semiconductors.philips.com).

© Koninklijke Philips Electronics N.V. 2002

SCA74

All rights are reserved. Reproduction in whole or in part is prohibited without the prior written consent of the copyright owner.

The information presented in this document does not form part of any quotation or contract, is believed to be accurate and reliable and may be changed without notice. No liability will be accepted by the publisher for any consequence of its use. Publication thereof does not convey nor imply any license under patent- or other industrial or intellectual property rights.

Printed in The Netherlands

613502/02/pp16

Date of release: 2002 May 23

Document order number: 9397 750 08395

*Let's make things better.*

**Philips  
Semiconductors**



**PHILIPS**