

**NOTES:**

1. MATERIALS: HOUSING--LIQUID CRYSTAL POLYMER (LCP), GLASS FILLED, UL94V-0, COLOR: BLACK, TERMINAL: PHOSPHOR BRONZE.
2. FINISH: 0.75 MICROMETERS MINIMUM SELECTIVE GOLD (Au) IN MATING AREA; 2.50 MICROMETERS MINIMUM SELECTIVE TIN (Sn) IN TAIL AREA; NICKEL (Ni) UNDERPLATE OVERALL.
3. THIS PART CONFORMS TO MOLEX PRODUCT SPECIFICATION PS-73670-9999.
4. FOR MIXED CONTACT MATING LENGTHS, CONSULT FACTORY FOR AVAILABILITY.
5. PACKAGE PER PK-70873-0818.
6. PARTS MARKED WITH PART NUMBER AND DATE CODE, ON EITHER SIDE, APPROXIMATELY WHERE SHOWN.

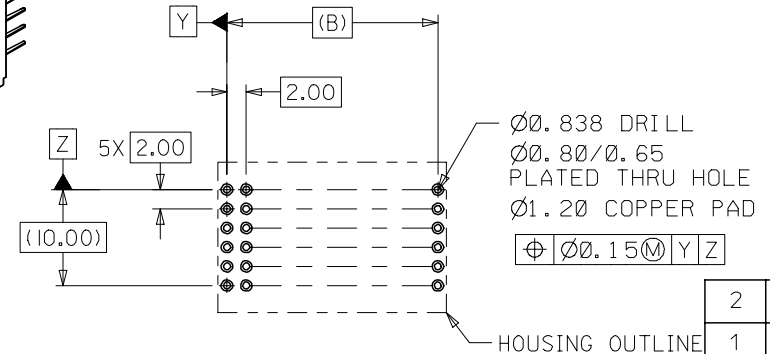
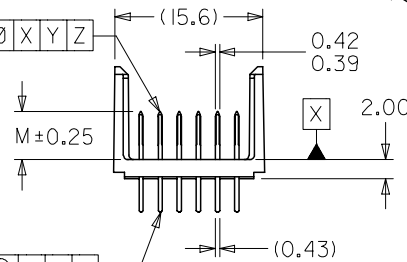
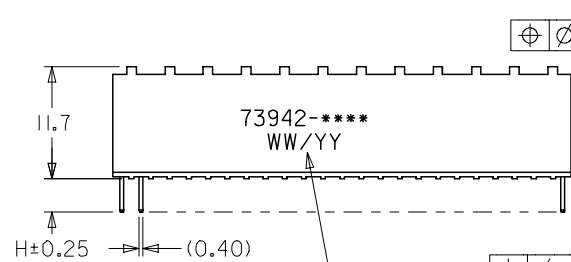
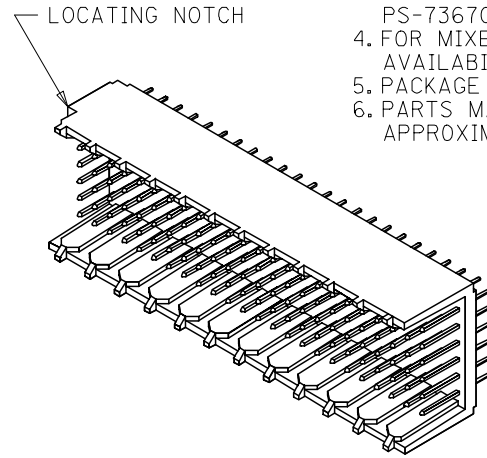
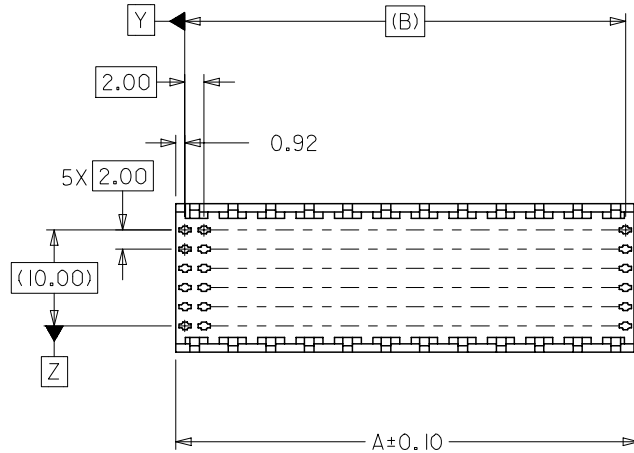

PCB LAYOUT: COMPONENT SIDE  
RECOMMENDED PCB THICKNESS: 2.50 MIN.

Ø0.838 DRILL  
Ø0.80/Ø.65  
PLATED THRU HOLE  
Ø1.20 COPPER PAD  
Ø0.15 X Y Z

2	A
1	G
SHT	REV

SEE NOTE 6

MODIFY FINISH NOTE	QUALITY SYMBOLS
EC NO: UCP2007-2259	▽=0
IDRW:MSIBARRA 2007/03/13	▽=0
CHKD:BBARKER 2007/03/21	
APPR:SMILLER 2007/03/22	
DESCRIPTION	
REV	



GENERAL TOLERANCES (UNLESS SPECIFIED)	DIMENSION STYLE	SCALE	DESIGN UNITS	THIRD ANGLE PROJECTION
	MM ONLY	2:1	METRIC	
4 PLACES ± --- ± ---	DRAWN BY	DATE	TITLE	
3 PLACES ± --- ± ---	JB INGHAM	1998/01/13	SALES ASSY HDM BACKPLANE	
2 PLACES ± 0.05 ± ---	CHECKED BY	DATE	OPEN END OPTION	
1 PLACE ± 0.10 ± ---	SREED	1998/01/13	SOLDER TAIL VERSION	
ANGULAR ±1/2°	APPROVED BY	DATE	MOLEX INCORPORATED	
	CBIXLER	1998/01/13	MATERIAL NO. SEE CHART	
			DOCUMENT NO. SD-73942-001	
DRAFT WHERE APPLICABLE MUST REMAIN WITHIN DIMENSIONS	SIZE	SHEET NO. 1 OF 2		
	B	THIS DRAWING CONTAINS INFORMATION THAT IS PROPRIETARY TO MOLEX INCORPORATED AND SHOULD NOT BE USED WITHOUT WRITTEN PERMISSION		

## MATERIAL NUMBER ASSIGNMENT

73942-\* \* 0 0

NUMBER	CIRCUIT SIZE	DIM "A"	DIM "B"	DIM "H"
0	72	23.84	22.00	2.0
1	144	47.84	46.00	2.0
2	72	23.84	22.00	2.5
3	144	47.84	46.00	2.5
4	72	23.84	22.00	3.0
5	144	47.84	46.00	3.0
6	72	23.84	22.00	3.5
7	144	47.84	46.00	3.5

NUMBER	DIM "M"
0	5.0
1	5.5
2	6.0

SEE SHEET 1 EC No. U8 1577 DRWN:JBINGHAM 98/0203 CHK: SREED 98/0203 APPR:CBIXLER 98/0203	MAJOR  CRITICAL 	QUALITY SYMBOLS	GENERAL TOLERANCES: (UNLESS SPECIFIED)	SCALE ---:--	DESIGN UNITS <input checked="" type="checkbox"/> mm <input type="checkbox"/> INCH	DIMENSIONS: <input type="checkbox"/> mm <input type="checkbox"/> INCH <input checked="" type="checkbox"/> mm ONLY	SHT REV		
		DRAWN BY & DATE JBINGHAM 98/01/13	THIRD ANGLE PROJECTION 		CHECKED BY & DATE SREED 98/01/13		TITLE: SALES ASSY, HDM BACKPLANE OPEN END OPTION SOLDER TAIL VERSION		
		APPROVED BY & DATE CBIXLER 98/01/13	ANGLAR: ± °		CAD FILENAME S73942X2.DGN		MOLEX INCORPORATED		
		DRAFT WHERE APPLICABLE MUST REMAIN WITHIN DIMENSIONS	THIS DRAWING CONTAINS INFORMATION THAT IS PROPRIETARY TO MOLEX INCORPORATED AND SHOULD NOT BE USED WITHOUT WRITTEN PERMISSION.		MATERIAL NO. SEE CHART	DRAWING NO. SD-73942-001	SHEET NO. 2	SIZE B	