

CFSH05-20L

**SURFACE MOUNT SILICON  
LOW  $V_F$  SCHOTTKY DIODE  
0.5 AMP, 20 VOLT**

**TLP**™  
Tiny  
Leadless  
Package

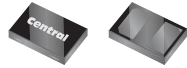

Top View Bottom View

**SOD-882L CASE**



[www.centrasemi.com](http://www.centrasemi.com)

**DESCRIPTION:**

The CENTRAL SEMICONDUCTOR CFSH05-20L is a silicon Schottky diode designed for applications where ultra small package size and energy efficiency are prime requirements. Packaged in the SOD-882L ultra low profile leadless case, this device provides exceptionally low forward voltage characteristics suitable for the most demanding size constrained battery powered applications.

**MARKING CODE: 2**

**APPLICATIONS:**

- DC-DC converters
- Voltage clamping
- Protection circuits
- Battery powered hand-held applications including cell phones, digital cameras, tablets and laptop computers

**FEATURES:**

- Current ( $I_O=500\text{mA}$ )
- Low forward voltage drop ( $V_F=220\text{mV TYP @ } 10\text{mA}$ )
- Low reverse current ( $8.0\mu\text{A TYP @ } 10\text{V}$ )
- Small, ultra low profile 1.0mm x 0.6mm x 0.4mm TLP™ leadless surface mount package

**MAXIMUM RATINGS:** ( $T_A=25^\circ\text{C}$ )

Peak Repetitive Reverse Voltage
DC Blocking Voltage
Average Forward Current
Peak Forward Surge Current, $t_p=8.3\text{ms}$
Power Dissipation
Operating and Storage Junction Temperature
Thermal Resistance

**SYMBOL**

$V_{RRM}$	20	V
$V_R$	20	V
$I_O$	500	mA
$I_{FSM}$	3.0	A
$P_D$	100	mW
$T_J, T_{stg}$	-65 to +150	$^\circ\text{C}$
$\theta_{JA}$	1000	$^\circ\text{C/W}$

**UNITS**

**ELECTRICAL CHARACTERISTICS:** ( $T_A=25^\circ\text{C}$  unless otherwise noted)

SYMBOL	TEST CONDITIONS	MIN	TYP	MAX	UNITS
$I_R$	$V_R=10\text{V}$		8.0	30	$\mu\text{A}$
$BV_R$	$I_R=500\mu\text{A}$	20			V
$V_F$	$I_F=0.1\text{mA}$		100	180	mV
$V_F$	$I_F=1.0\text{mA}$		160	240	mV
$V_F$	$I_F=10\text{mA}$		220	290	mV
$V_F$	$I_F=100\text{mA}$		310	380	mV
$V_F$	$I_F=500\text{mA}$		450	500	mV
$C_J$	$V_R=1.0\text{V}, f=1.0\text{MHz}$		21	30	pF

R2 (25-April 2013)

CFSH05-20L

**SURFACE MOUNT SILICON  
LOW  $V_F$  SCHOTTKY DIODE  
0.5 AMP, 20 VOLT**



**SOD-882L CASE - MECHANICAL OUTLINE**

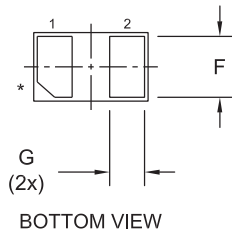
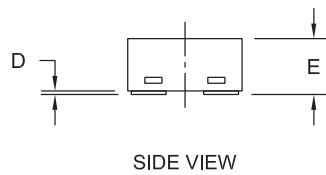
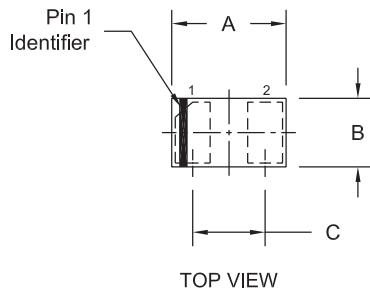

\* Pin 1 chamfer may appear on any corner.

SYMBOL	INCHES		MILLIMETERS	
	MIN	MAX	MIN	MAX
A	0.037	0.041	0.95	1.05
B	0.022	0.026	0.55	0.65
C	0.026		0.65	
D	0.000	0.002	0.00	0.05
E	0.012	0.016	0.30	0.40
F	0.018	0.022	0.45	0.55
G	0.008	0.012	0.20	0.30

SOD-882L (REV:R2)

**LEAD CODE:**

- 1) Cathode
- 2) Anode

**MARKING CODE: 2**

R2

R2 (25-April 2013)

CFSH05-20L

SURFACE MOUNT SILICON  
LOW  $V_F$  SCHOTTKY DIODE  
0.5 AMP, 20 VOLT



### TYPICAL ELECTRICAL CHARACTERISTICS

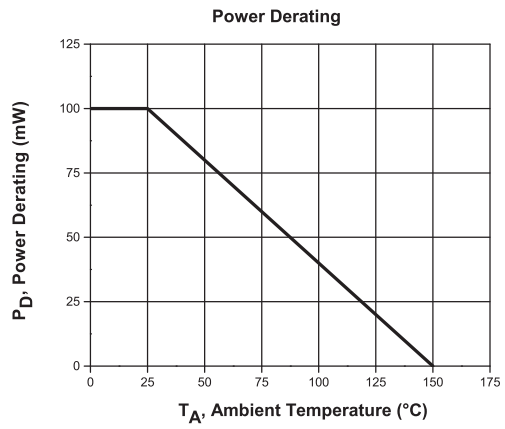
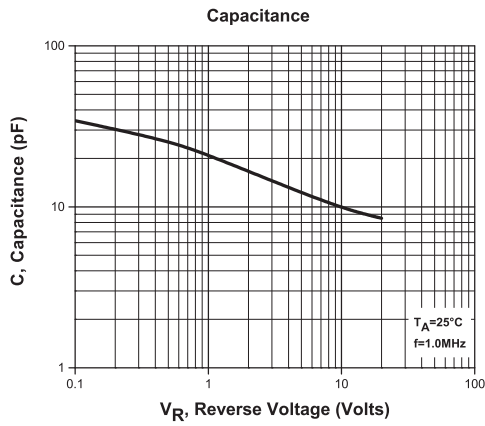
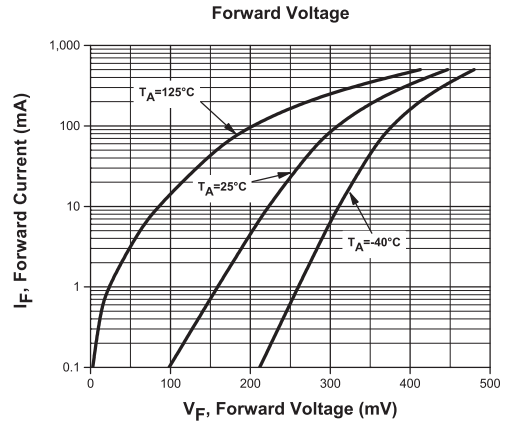
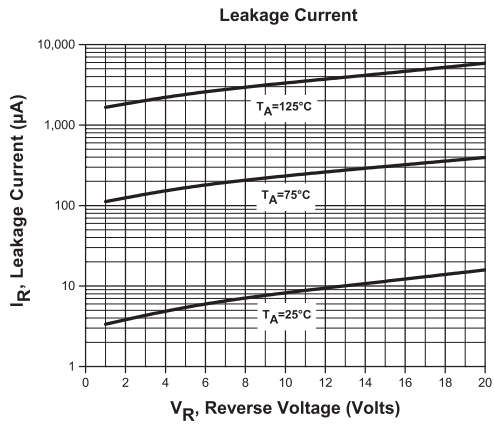

R2 (25-April 2013)

## OUTSTANDING SUPPORT AND SUPERIOR SERVICES



---

### PRODUCT SUPPORT

Central's operations team provides the highest level of support to insure product is delivered on-time.

- Supply management (Customer portals)
- Inventory bonding
- Consolidated shipping options
- Custom bar coding for shipments
- Custom product packing

---

### DESIGNER SUPPORT/SERVICES

Central's applications engineering team is ready to discuss your design challenges. Just ask.

- Free quick ship samples (2<sup>nd</sup> day air)
- Online technical data and parametric search
- SPICE models
- Custom electrical curves
- Environmental regulation compliance
- Customer specific screening
- Up-screening capabilities
- Special wafer diffusions
- PbSn plating options
- Package details
- Application notes
- Application and design sample kits
- Custom product and package development

---

### REQUESTING PRODUCT PLATING

1. If requesting Tin/Lead plated devices, add the suffix "TIN/LEAD" to the part number when ordering (example: 2N2222A TIN/LEAD).
2. If requesting Lead (Pb) Free plated devices, add the suffix "PBFREE" to the part number when ordering (example: 2N2222A PBFREE).

---

### CONTACT US

#### Corporate Headquarters & Customer Support Team

Central Semiconductor Corp.  
145 Adams Avenue  
Hauppauge, NY 11788 USA  
Main Tel: (631) 435-1110  
Main Fax: (631) 435-1824  
Support Team Fax: (631) 435-3388  
[www.centrasemi.com](http://www.centrasemi.com)

**Worldwide Field Representatives:**  
[www.centrasemi.com/wwreps](http://www.centrasemi.com/wwreps)

**Worldwide Distributors:**  
[www.centrasemi.com/wwdistributors](http://www.centrasemi.com/wwdistributors)

---

For the latest version of Central Semiconductor's **LIMITATIONS AND DAMAGES DISCLAIMER**, which is part of Central's Standard Terms and Conditions of sale, visit: [www.centrasemi.com/terms](http://www.centrasemi.com/terms)