

# ABC400 Series AC-DC Open Frame Power Supplies

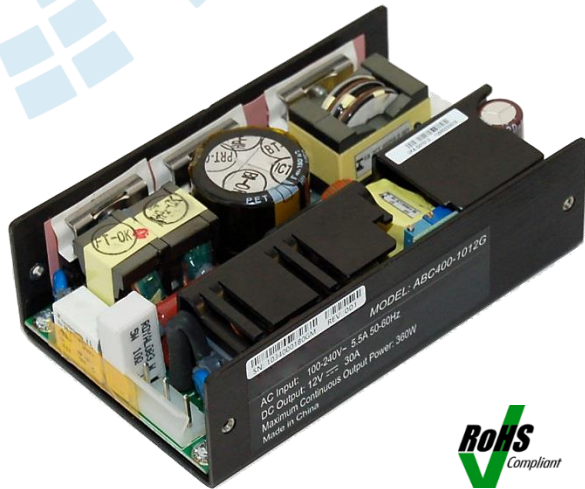

## Key Features & Benefits

- High Efficiency up to 91% at 230 VAC
- Universal AC Input Voltage Range: 90-264 VAC
- Active Power Factor Correction
- Over temperature, output overvoltage, overcurrent and short circuit protection
- Low Conducted and Radiated EMI (EN 55022 cl A)
- Safety approved to the latest edition of the following standards: CSA/UL60950-1, EN60950-1 and IEC60950-1
- High Power Density Design: 16 W/in<sup>3</sup>
- Compact Size: 3.0 (W) x 1.5 (H) x 5.0 (L) inches
- RoHS Compliant
- CE Marked

ABC400 Series is a compact and efficient series of AC-DC open frame power supplies suited for telecom, datacom and many other applications.

The family meets the international information technology safety standards with the CE-Mark for the European Low Voltage Directive (LVD).

Their high efficiency allows a very minimal power loss in end equipment, resulting in higher reliability, ease of thermal management and regulatory approvals for an environmentally friendly end product.

## Applications

- Telecom
- Datacom
- Industrial Applications

### North America

+1-866.513.2839

### Asia-Pacific

+86.755.29885888

### Europe, Middle East

+353 61 225 977

tech.support@psbel.com  
[belpowersolutions.com](http://belpowersolutions.com)

# ABC400 Series

## ORDERING INFORMATION

MODEL	INPUT VOLTAGE RANGE	OUTPUT VOLTAGE	NOM OUTPUT CURRENT	# OF OUTPUTS	OUTPUT POWER
ABC400-1012G	90 – 264 VAC	12 VDC	23 A	1	400 W
ABC400-1024G	90 – 264 VAC	24 VDC	13 A	1	400 W
ABC400-1048G	90 – 264 VAC	48 VDC	6.5 A	1	400 W

## OVERVIEW

The ABC400-10XXG is a high efficiency and high power density AC to DC power supply. It incorporates interleaved transition mode PFC converter and well proven two-FET forward converter, providing increased system reliability and high efficiency with around 1m/s system air cooling, ABC400-1012G can delivery up to 360W continuous output power and 408W for ABC400-1024G and ABC400-1048G.

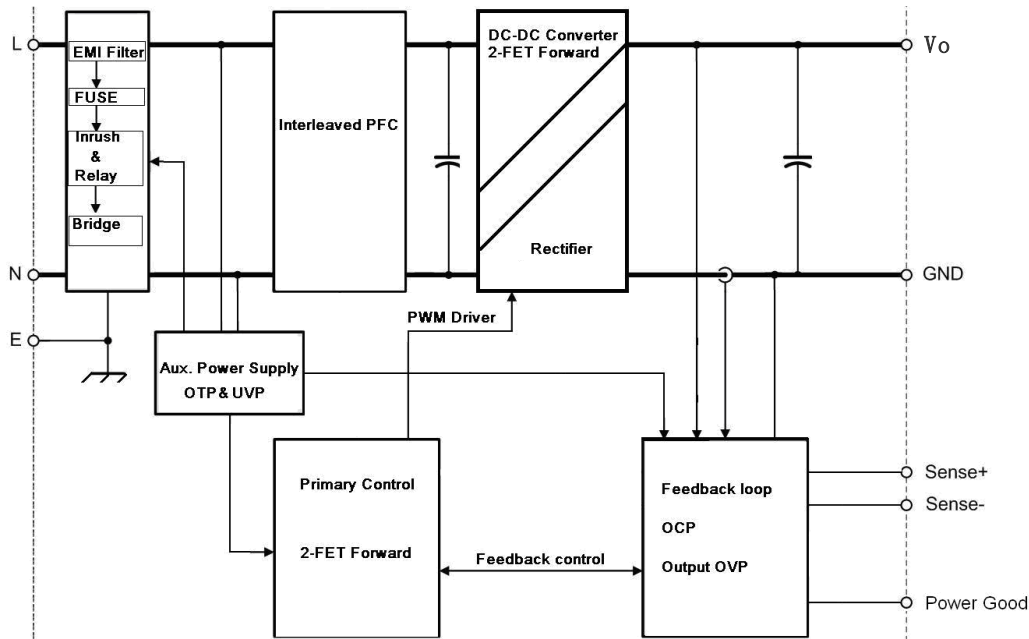

Figure 1: ABC400-10XXG block diagram

## ABSOLUTE MAXIMUM RATINGS

Stresses in excess of the absolute maximum ratings may cause performance degradation, adversely affect long-term reliability, and cause permanent damage to the supply.

PARAMETER	CONDITIONS / DESCRIPTION	MIN	NOM	MAX	UNIT
$V_{max}$	Max Continuous Input			264	VAC
				300	VAC

## ENVIRONMENTAL AND MECHANICAL

PARAMETER	CONDITIONS / DESCRIPTION	MIN	NOM	MAX	UNIT
$T_A$	Ambient temperature	-10		+50	°C
$T_{Aext}$	Extended temp range	+50		+70	°C
$T_S$	Storage temperature	-40		+85	°C
Dimensions	Width		76.2		mm
	Height		38.1		mm
	Depth		127.0		mm
$M$	Weight		0.5		kg

+1.866.513.2839  
tech.support@psbel.com  
belpowersolutions.com

# ABC400 Series

## INPUT SPECIFICATIONS

General Condition:  $T_A = -10... 50\text{ }^\circ\text{C}$  unless otherwise noted. Active fan air cooling required: 200 LFM (1 m/s)

PARAMETER	CONDITIONS / DESCRIPTION	MIN	NOM	MAX	UNIT
$V_{nom}$	Nominal input voltage	100		240	VAC
$V_i$	Input voltage ranges	Normal operating ( $V_{i min}$ to $V_{i max}$ )		264	VAC
$I_{max}$	Max input current			6.5	$A_{rms}$
$I_p$	Inrush current limitation	$V_{nom} = 115\text{ VAC}$ , $T = 25\text{ }^\circ\text{C}$ (see Figure 2) $V_{nom} = 230\text{ VAC}$ , $T = 25\text{ }^\circ\text{C}$ (see Figure 3)		30 60	$A_p$
$F_i$	Input frequency	47	50/60	63	Hz
PF	Power factor	$V_{nom} = 264\text{ VAC}$ , $> 0.5 I_{o nom}$			W/VA
$V_{i on}$	Turn-on input voltage <sup>1</sup>	Ramping up		88	VAC
$V_{i off}$	Turn-off input voltage <sup>1</sup>	Ramping down		80	VAC
$\eta$	Efficiency	$V_{nom} = 230\text{ VAC}$ , $0.5 \cdot I_{o nom}$ , $V_o nom$ , $T_A = 25\text{ }^\circ\text{C}$ $V_{nom} = 230\text{ VAC}$ , $1.0 \cdot I_{o nom}$ , $V_o nom$ , $T_A = 25\text{ }^\circ\text{C}$		89 90	%
$T_{hold}$	Hold-up Time	After last AC zero point, $V_o$ within regulation, $V_i = 115\text{ VAC}$ , $P_o nom$		16	ms

## INPUT FUSE

A slow-blow 8A input fuses (5 × 20 mm) in series with live line inside the power supply protects against severe defects. The fuse and a VDR form together with the input filter an effective protection against high input transients.

## INRUSH CURRENT

The AC-DC power supply exhibits an X-capacitance of only 1.47  $\mu\text{F}$ , resulting in a low and short peak current, when the supply is connected to the mains. The internal bulk capacitor will be charged through an power resistor which will limit the inrush current (see *Figure 2 and 3*).

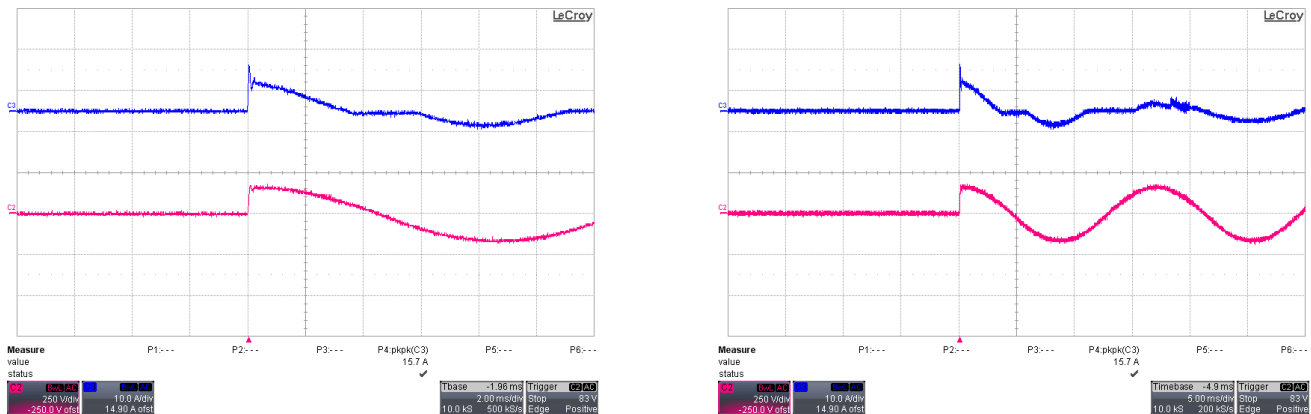

Figure 2: Inrush current,  $V_{in} = 115\text{ Vac}$ ,  $90^\circ$  CH2:  $V_{in}$  (250V/div), CH3:  $I_{in}$  (10A/div)

<sup>1</sup> The power supply is provided with a minimum hysteresis of 8 V during turn-on and turn-off within the ranges.

# ABC400 Series

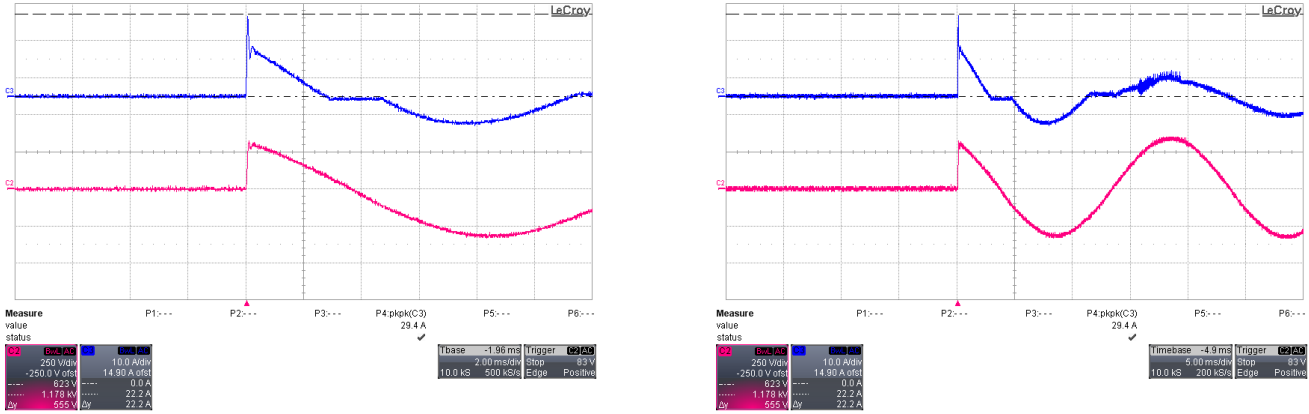

Figure 3: Inrush current,  $V_{in} = 230Vac$ ,  $90^\circ$  CH2:  $V_{in}$  (250V/div), CH3:  $I_{in}$  (10A/div)

## INPUT UNDER-VOLTAGE

If the sinusoidal input voltage stays below the input under voltage lockout threshold  $V_{on}$ , the supply will be inhibited. Once the input voltage returns within the normal operating range, the supply will return to normal operation again.

## POWER FACTOR CORRECTION

Power factor correction (PFC) is achieved by controlling the input current waveform synchronously with the input voltage. A specified PFC controller is implemented in the interleaved transition mode topology giving outstanding PFC results over a wide input voltage and load ranges. The input current will follow the shape of the input voltage.

## EFFICIENCY

The high efficiency (see Figure 4, 5 and 6) is achieved by using state-of-the-art silicon power devices in conjunction with interleaved transition mode PFC topology minimizing switching losses. Synchronous rectifiers on the output reduce the losses in the high current output path for ABC400-1012G schottky diode and ultra-fast diode are used as rectifiers for ABC400-1024G and ABC400-1048G due to the high output voltage level.

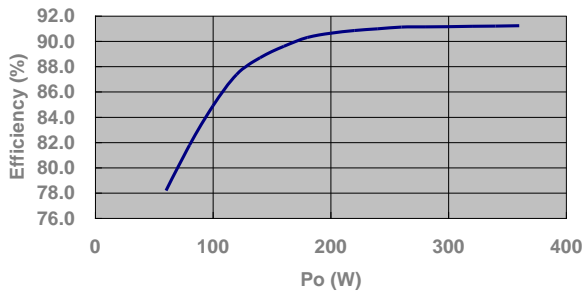

Figure 4: Efficiency vs. Output Power at 230VAC, ABC400-1012G

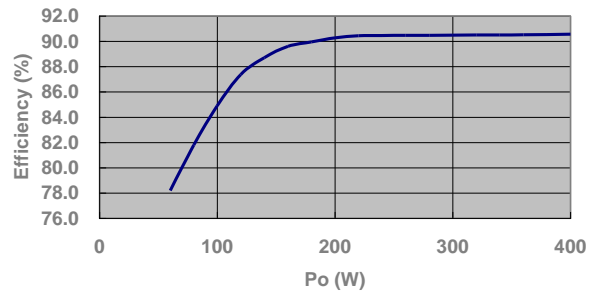

Figure 5: Efficiency vs. Output Power at 230VAC, ABC400-1024G

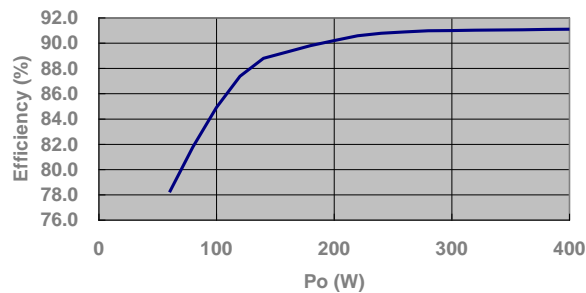

Figure 6: Efficiency vs. Output Power at 230VAC, ABC400-1048G

# ABC400 Series

## OUTPUT SPECIFICATIONS

General Condition:  $T_A = -10 \dots +50 \text{ }^\circ\text{C}$  unless otherwise noted. Active fan air cooling required: 200 LFM (1 m/s)

PARAMETER	CONDITIONS / DESCRIPTION		MIN	NOM	MAX	UNIT	
<b>Main Output <math>V_o</math></b>							
$V_o$	Nominal Output Voltage	$0.5 \cdot I_o, T_{amb} = 25 \text{ }^\circ\text{C}$	ABC400-1012G	12.0		VDC	
			ABC400-1024G	24.0		VDC	
			ABC400-1048G	48.0		VDC	
$V_{o\text{ set}}$	Output Set Point Accuracy	$0.5 \cdot I_o, T_{amb} = 25 \text{ }^\circ\text{C}$	ABC400-1012G	-50	50	mV	
			ABC400-1024G	-75	75	mV	
			ABC400-1048G	-150	150	mV	
$P_{o\text{ nom}}$	Nominal Output Power		ABC400-1012G	0	276	360	W
			ABC400-1024G	0	312	408	W
			ABC400-1048G	0	312	408	W
$I_{o\text{ nom}}$	Nominal Output Current		ABC400-1012G	0	23	30	A
			ABC400-1024G	0	13	17	A
			ABC400-1048G	0	6.5	8.5	A
$V_{o\text{ p-p}}$	Output Ripple Voltage	$V_{o\text{ nom}}, I_{o\text{ nom}}, 20 \text{ MHz BW}$	ABC400-1012G		60	120	mVpp
			ABC400-1024G		80	240	mVpp
			ABC400-1048G		150	480	mVpp
$dV_{o\text{ Load}}$	Load Regulation	$V_i = V_{i\text{ nom}}, 0 - 100 \% I_{o\text{ nom}}$	ABC400-1012G	-360	50	360	mV
			ABC400-1024G	-720	80	720	mV
			ABC400-1048G	-1440	130	1440	mV
$dV_{o\text{ Line}}$	Line Regulation	$V_i = V_{i\text{ min}} \dots V_{i\text{ max}}$	ABC400-1012G	-360	80	360	mV
			ABC400-1024G	-720	120	720	mV
			ABC400-1048G	-1440	150	1440	mV
$dV_{\text{dyn}}$	Dynamic Load Regulation	$\Delta I_o = 50\% I_{o\text{ nom}},$ $I_o = 50 \dots 100\% I_{o\text{ nom}},$ $dI_o/dt = 1\text{A}/\mu\text{s},$ recovery within 5% of $V_{o\text{ nom}}$	ABC400-1012G	-0.6	0.25	0.6	V
			ABC400-1024G	-1.2	0.45	1.2	V
			ABC400-1048G	-2.4	0.7	2.4	V
$t_{\text{rec}}$	Recovery Time				2	ms	
$t_{\text{delay}}$	Turn-On Delay	Time required for output within regulation after initial application of AC input @ 90 VAC	0	1	2	Sec	
$t_{\text{rise}}$	Turn On Rise Time	$V_o = 10 \dots 90\% V_{o\text{ nom}}$	ABC400-1012G		20	ms	
			ABC400-1024G		20	ms	
			ABC400-1048G		30	ms	
$C_{\text{Load}}$	Capacitive Loading		ABC400-1012G		6600	$\mu\text{F}$	
			ABC400-1024G		3740	$\mu\text{F}$	
			ABC400-1048G		1870	$\mu\text{F}$	

+1.866.513.2839  
tech.support@psbel.com  
belpowersolutions.com

# ABC400 Series

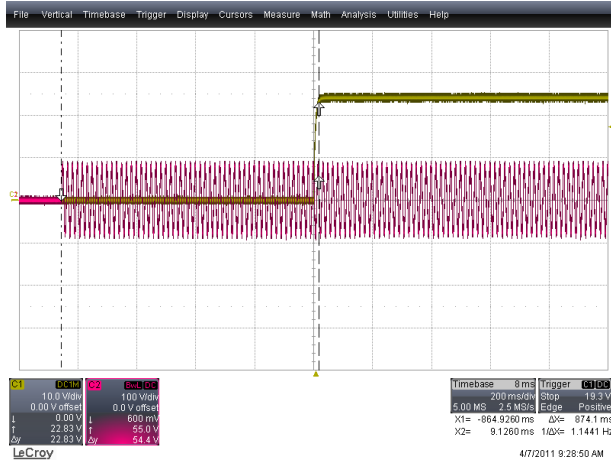

Figure 7: Turn-On AC Line 115 VAC, full load (200 ms/div)  
CH1:  $V_o$  (10 V/div) CH2:  $V_{in}$  (100 V/div)

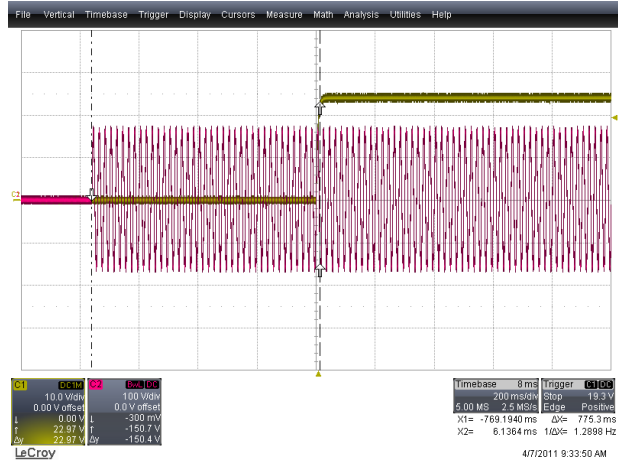

Figure 8: Turn-On AC Line 230 VAC, full load (200 ms/div)  
CH1:  $V_o$  (10 V/div) CH2:  $V_{in}$  (100 V/div)

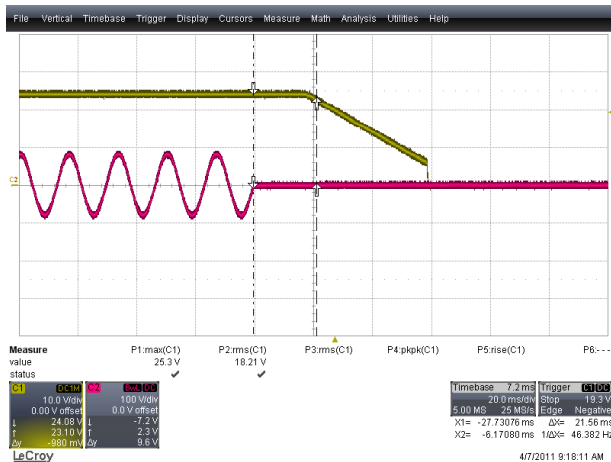

Figure 9: Turn-Off AC Line 115 VAC, full load (10 ms/div)  
CH1:  $V_o$  (10 V/div) CH2:  $V_{in}$  (100 V/div)

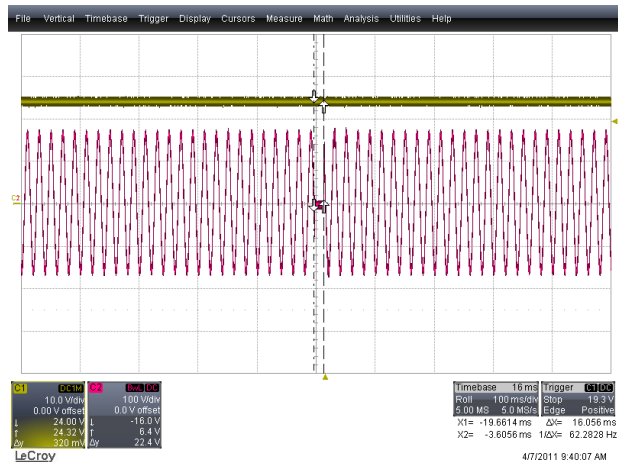

Figure 10: AC drop out 16ms (100 ms/div)  
CH1:  $V_o$  (10 V/div) CH2:  $V_{in}$  (100 V/div)

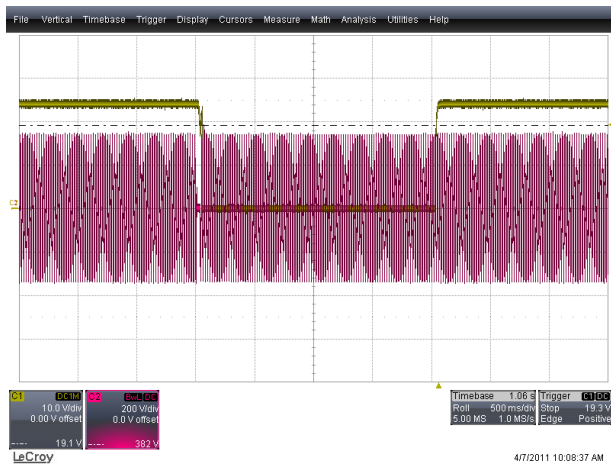

Figure 11: AC drop out 30ms (500 ms/div),  $V_o$  restart  
CH1:  $V_o$  (10 V/div) CH2:  $V_{in}$  (200 V/div)

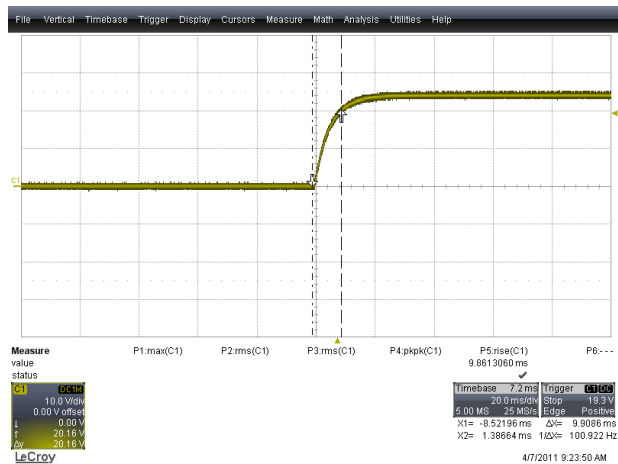

Figure 12:  $V_o$  rise time at 115VAC (20 ms/div)  
CH1:  $V_o$  (10 V/div)

# ABC400 Series

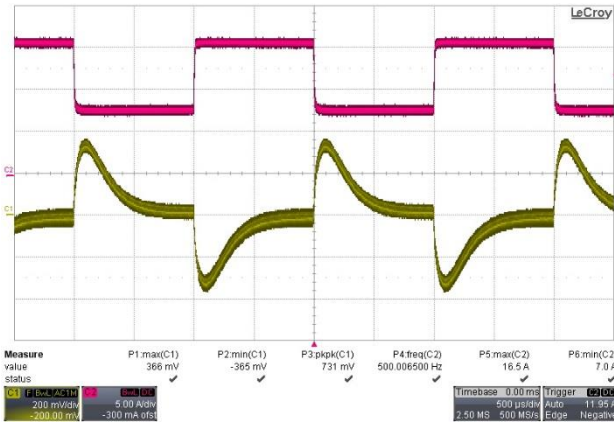

Figure 13: Load transient  $V_o$  (500µs/div), 8.5A <-> 17A 2A/µs  
CH1:  $V_o$  (200mV/div) CH2:  $I_o$  (5.0 A/div)

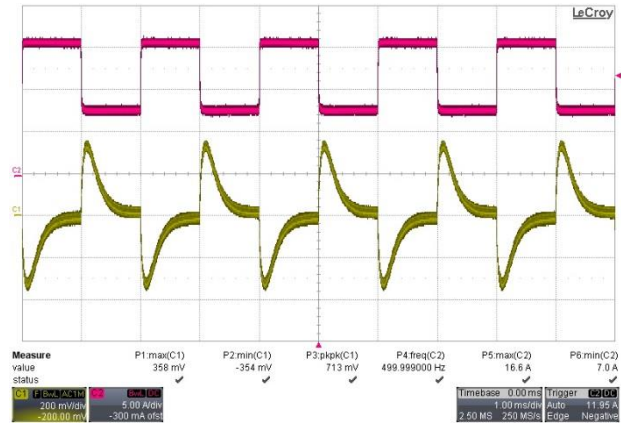

Figure 14: Load transient  $V_o$  (1.0ms/div), 8.5A <-> 17A, 2A/µs  
CH1:  $V_o$  (200 mV/div) CH2:  $I_o$  (5 A/div)

## PROTECTION

PARAMETER	CONDITIONS / DESCRIPTION	MIN	NOM	MAX	UNIT	
F	Input Fuses (L only)	Not user accessible, time lag characteristic		8.0	A	
$V_o$ ov	OV Threshold	ABC400-1012G	14.0	16.0	VDC	
		ABC400-1024G	28.0	32.0	VDC	
		ABC400-1048G	53	57	VDC	
$I_o$ lim	Current Limit	$V > 90$ VAC, $-10$ °C $< T_a < 50$ °C				
		ABC400-1012G	31.5	33.0	39.0	A
		ABC400-1024G	20.0	21.0	23.0	A
ABC400-1048G	8.9	10	11.1	A		
$T_{SD}$	Over Temperature on Heat Sinks	Automatic shut-down		100	°C	

## OVERVOLTAGE PROTECTION

The AC-DC power supply provides a fixed threshold overvoltage (OV) protection implemented with a HW comparator. Once an OV condition has been triggered, the supply will shut down and latch the fault condition. The latch can be unlocked by disconnecting the supply from the AC mains only.

## CURRENT LIMITATION

The main output current limitation will decrease with linear derating to 50% at 70 °C if the ambient (inlet) temperature increases beyond 50 °C (see Figure 15).

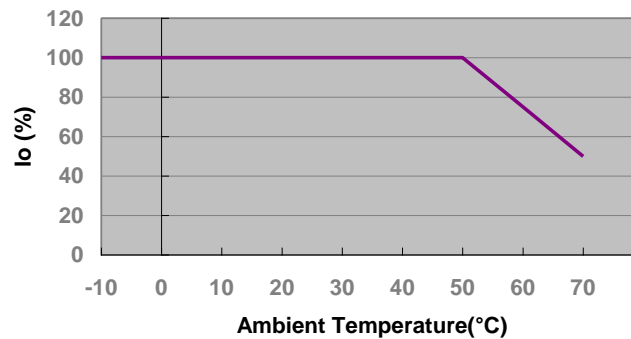

Figure 15: Output Current Limitation Curve

+1.866.513.2839  
tech.support@psbel.com  
belpowersolutions.com

# ABC400 Series

## POWER GOOD SIGNAL

The Out-OK output gives a status indication of the converter and the output voltages. It can be used for control functions such as data protection, central system monitoring or as a part of a self-testing system. Connecting the Out-OK as shown in *Figure 16*,  $V_{OK} < 1.0\text{ V}$  indicates that the output voltage(s) of the converter are within the range.

Note: using the potentiometer, the monitor level tracks the programmed output voltage. In an error condition, if the output voltage is out of range due to overload or an external overvoltage,  $V_{OK}$  will approach  $V_p$ . The output is formed by an NPN transistor. The signal is isolated from the output.

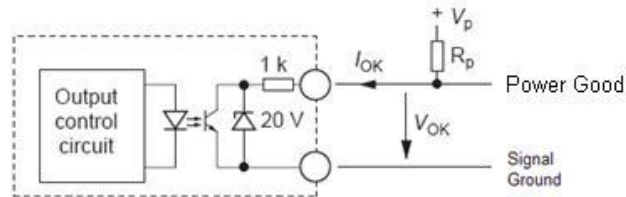

Figure 16: Power Good signal

Power Good Signal Description:

1. O/P V OK – Signal Low, Opto conducting, (max sink current 0.5 mA)
2. O/P V Bad – Signal High, Opto opening, (max leakage current 25  $\mu\text{A}$ )

## ELECTROMAGNETIC COMPATIBILITY

### IMMUNITY

**Note:** Most of the immunity requirements are derived from EN 55024:1998/A2:2003.

TEST	STANDARD / DESCRIPTION	CRITERIA
ESD Contact Discharge	EN 61000-4-2, Level 2	A
RF Susceptibility	EN 61000-4-3, Level 3	A
Fast Transient/Burst	EN 61000-4-4, Level 3	B
Surge	EN 61000-4-5, Class 3	B
RF Conducted Immunity	EN 61000-4-6, Class 3	A
Voltage Dips and Interruptions	EN 61000-4-11	C
Magnetic Fields	EN 61000-4-8	A



# ABC400 Series

## SAFETY / APPROVALS

Maximum electric strength testing is performed in the factory according to IEC/EN 60950, and UL 60950. Input-to-output electric strength tests should not be repeated in the field. Bel Power Solutions will not honor any warranty claims resulting from electric strength field tests.

PARAMETER	DESCRIPTION / CONDITIONS	MIN	NOM	MAX	UNIT
Safety Approvals	Safety approved to the latest edition of the following standards: CSA/UL60950-1, EN60950-1 and IEC60950-1. CE Mark for LVD CB Approval				
Insulation Safety Rating	Input / Case		Basic		
	Input / Output		Reinforced		
	Output / Case		Functional		
dc Creepage / Clearance	Primary (L/N) to protective earth (PE)		According to safety standard		mm
	Primary to secondary				mm
Electrical Strength Test	Input to case		2121		VDC
	Input to output		4242		VDC
	Output and Signals to case		707		VDC

## MECHANICAL DIMENSIONS

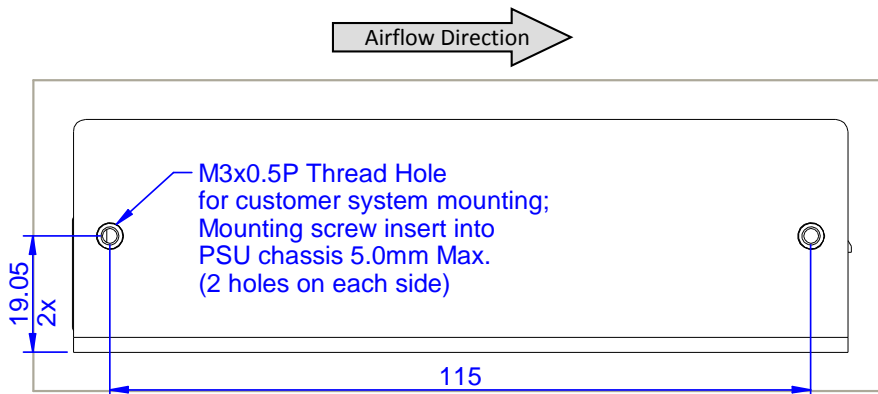

Figure 17: Side view 1

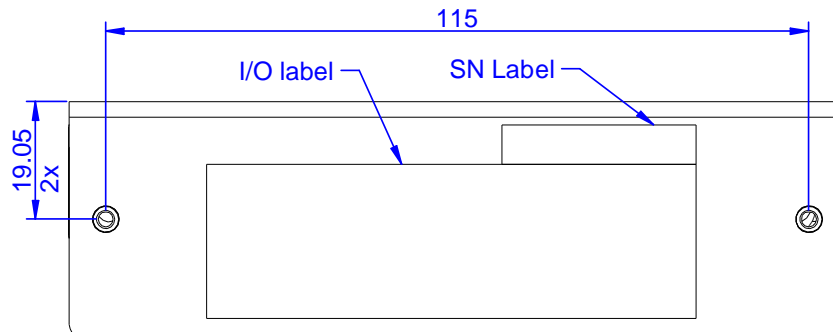
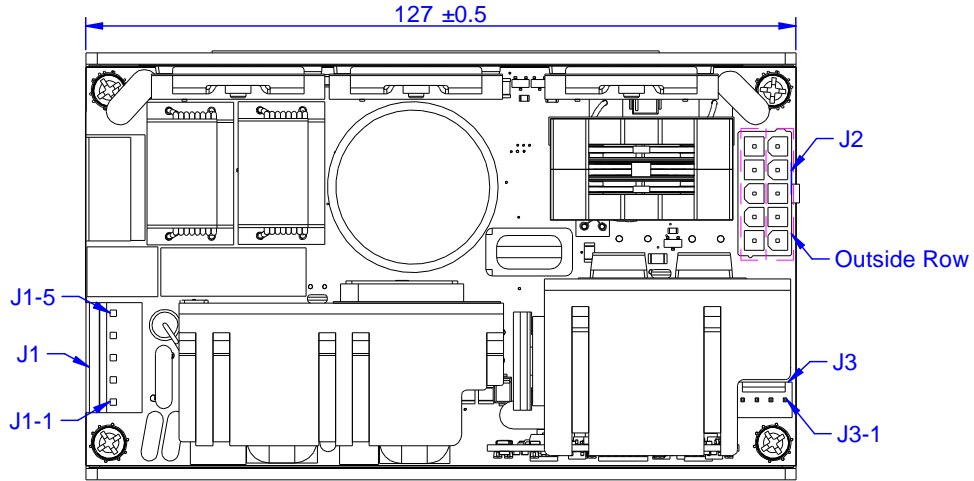

Figure 18: Side view 2

**Note:** A 3D step file of the power supply casing is available on request.

+1.866.513.2839  
tech.support@psbel.com  
belpowersolutions.com

# ABC400 Series



Airflow Direction → Figure 19: Top view

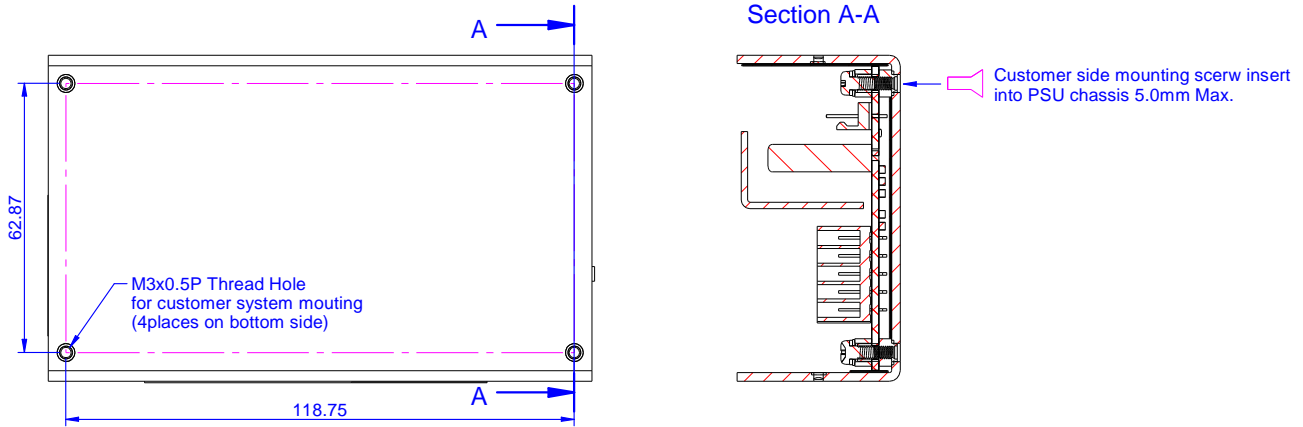

Figure 20: Bottom view 2

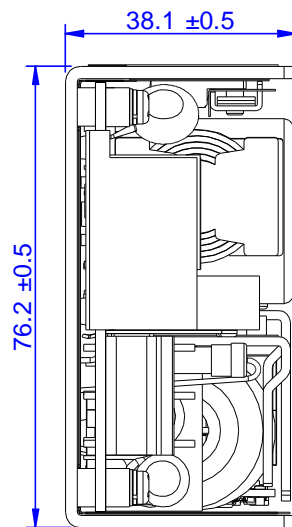

Figure 21: Front view

+1.866.513.2839  
 tech.support@psbel.com  
 belpowersolutions.com

# ABC400 Series

## CONNECTIONS

PIN	NAME	DESCRIPTION
<b>Input Connector J1</b>		
J1- 1	Earth	AC Input Earth
J1- 2	Not fitted	NA
J1- 3	Live	AC Input Live
J1- 4	Not fitted	NA
J1- 5	Neutral	AC Input Neutral
<b>Output Connector J2</b>		
J2-outside row	+Vo	+12V / +24V / +48V Output
J2-inside row	-Vo	+12V / +24V / +48V Output Return
<b>Signal Connector J3</b>		
J3- 1	-Vo Sense	Output Negative Sense
J3- 2	+Vo Sense	Output Positive Sense
J3- 3	Power Good	Power Good Signal
J3- 4	Power Good Return	Power Good Signal Return

Connector Mating Parts (Molex or equivalent)

CONNECTOR	HOUSING	CRIMP TERMINAL	WIRE GAUGE
J1	09-50-3051	08-50-0105	AWG#18
J2	39-01-2105	44476-3112	AWG#16
J3	22-01-3047	08-50-0113	AWG#22-30

**For more information on these products consult: [tech.support@psbel.com](mailto:tech.support@psbel.com)**

**NUCLEAR AND MEDICAL APPLICATIONS** - Products are not designed or intended for use as critical components in life support systems, equipment used in hazardous environments, or nuclear control systems.

**TECHNICAL REVISIONS** - The appearance of products, including safety agency certifications pictured on labels, may change depending on the date manufactured. Specifications are subject to change without notice.

+1.866.513.2839  
[tech.support@psbel.com](mailto:tech.support@psbel.com)  
[belpowersolutions.com](http://belpowersolutions.com)