

650 V power Schottky silicon carbide diode

Datasheet - production data

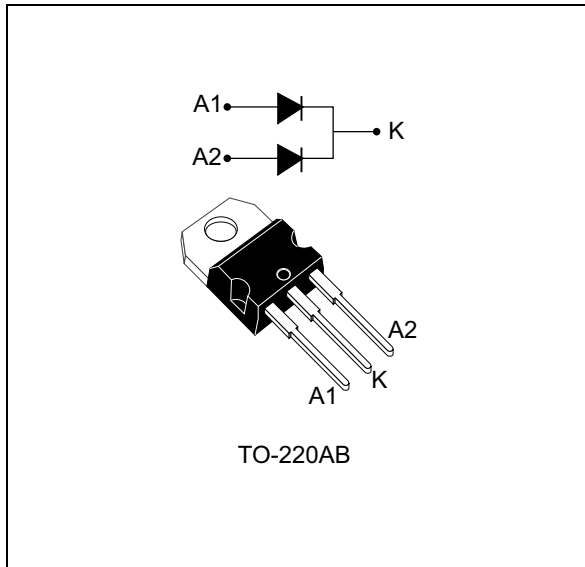

Description

The SiC diode is an ultrahigh performance power Schottky diode. It is manufactured using a silicon carbide substrate. The wide band gap material allows the design of a Schottky diode structure with a 650 V rating. Due to the Schottky construction, no recovery is shown at turn-off and ringing patterns are negligible. The minimized capacitive charge at turn-off behavior is independent of temperature.

Especially suited for use in interleaved or bridgeless topologies, this dual-diode rectifier will boost the performance in hard switching conditions. Its high forward surge capability ensures a good robustness during transient phases.

Table 1. Device summary

Symbol	Value
$I_{F(AV)}$	2 x 6 A
V_{RRM}	650 V
T_j (max)	175 °C

Features

- No or negligible reverse recovery
- Switching behavior independent of temperature
- High forward surge capability
- ECOPACK[®]2 compliant component

1 Characteristics

Table 2. Absolute ratings (limiting values per diode at 25 °C unless otherwise specified)

Symbol	Parameter		Value	Unit	
V_{RRM}	Repetitive peak reverse voltage		650	V	
$I_{F(RMS)}$	Forward rms current		22	A	
$I_{F(AV)}$	Average forward current	$T_c = 135\text{ °C}^{(1)}$, DC	Per diode	6	A
		$T_c = 135\text{ °C}^{(2)}$, DC	Per device	12	A
I_{FSM}	Surge non repetitive forward current	$t_p = 10\text{ ms}$ sinusoidal, $T_c = 25\text{ °C}$		60	A
		$t_p = 10\text{ ms}$ sinusoidal, $T_c = 125\text{ °C}$		52	
		$t_p = 10\text{ }\mu\text{s}$ square, $T_c = 25\text{ °C}$		400	
I_{FRM}	Repetitive peak forward current	$T_c = 135\text{ °C}^{(1)}$, $T_j = 175\text{ °C}$, $\delta = 0.1$	25	A	
T_{stg}	Storage temperature range		-65 to +175	°C	
T_j	Operating junction temperature ⁽³⁾		-40 to +175	°C	

1. Value based on $R_{th(j-c)}$ max (per diode)
2. Value based on $R_{th(j-c)}$ max (per device)
3. $\frac{dP_{tot}}{dT_j} < \frac{1}{R_{th(j-a)}}$ condition to avoid thermal runaway for a diode on its own heatsink

Table 3. Thermal resistance parameters

Symbol	Parameter		Typ.	Max.	Unit
$R_{th(j-c)}$	Junction to case	Per diode	1.6	2.4	°C/W
		Per device	0.875	1.275	
$R_{th(c)}$	Coupling		-	0.15	

When the diodes 1 and 2 are used simultaneously:

$$\Delta T_j(\text{diode 1}) = P(\text{diode1}) \times R_{th(j-c)}(\text{Per diode}) + P(\text{diode2}) \times R_{th(c)}$$

Table 4. Static electrical characteristics (per diode)

Symbol	Parameter	Tests conditions		Min.	Typ.	Max.	Unit
$I_R^{(1)}$	Reverse leakage current	$T_j = 25\text{ °C}$	$V_R = V_{RRM}$	-	5	60	μA
		$T_j = 150\text{ °C}$		-	50	250	
$V_F^{(2)}$	Forward voltage drop	$T_j = 25\text{ °C}$	$I_F = 6\text{ A}$	-	1.56	1.75	V
		$T_j = 150\text{ °C}$		-	1.98	2.5	

1. $t_p = 10\text{ ms}$, $\delta < 2\%$
2. $t_p = 500\text{ }\mu\text{s}$, $\delta < 2\%$

To evaluate the conduction losses use the following equation:

$$P = 1.35 \times I_{F(AV)} + 0.192 \times I_{F(RMS)}^2$$

Table 5. Dynamic electrical characteristics (per diode)

Symbol	Parameter	Test conditions	Typ.	Unit
$Q_{cj}^{(1)}$	Total capacitive charge	$V_R = 400\text{ V}$	18	nC
C_j	Total capacitance	$V_R = 0\text{ V}, T_C = 25\text{ }^\circ\text{C}, F = 1\text{ MHz}$	300	pF
		$V_R = 400\text{ V}, T_C = 25\text{ }^\circ\text{C}, F = 1\text{ MHz}$	30	

1. Most accurate value for the capacitive charge: $Q_{cj} = \int_0^{V_{OUT}} c_j(V_R) \cdot dV_R$

Figure 1. Forward voltage drop versus forward current (typical values, low level, per diode)

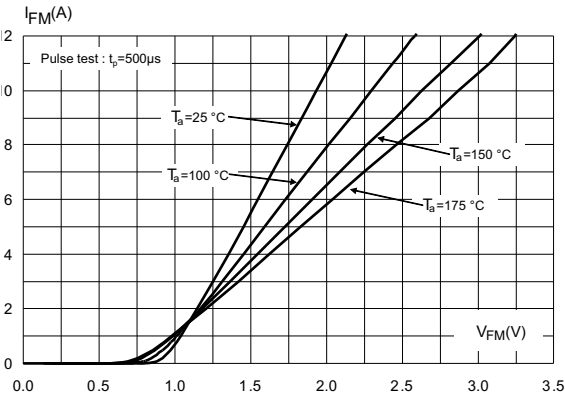

Figure 2. Forward voltage drop versus forward current (typical values, high level, per diode)

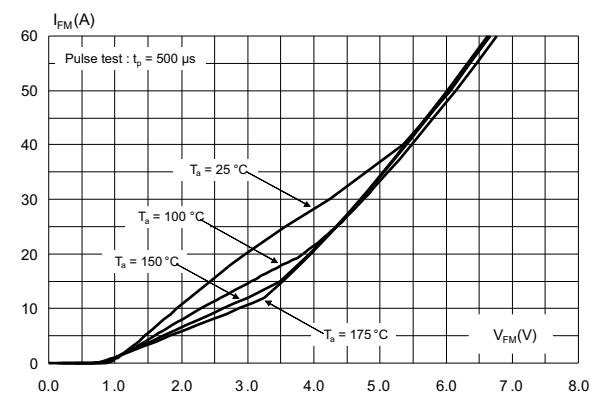

Figure 3. Reverse leakage current versus reverse voltage applied (typical values, per diode)

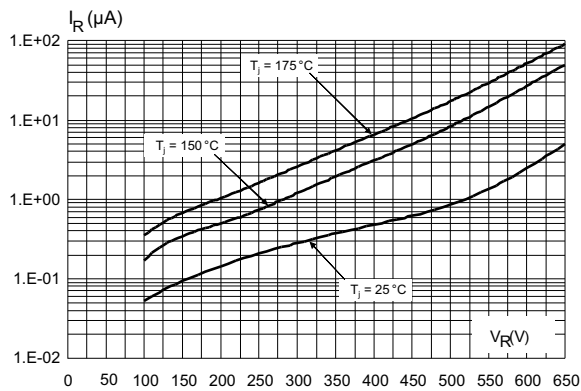

Figure 4. Peak forward current versus case temperature

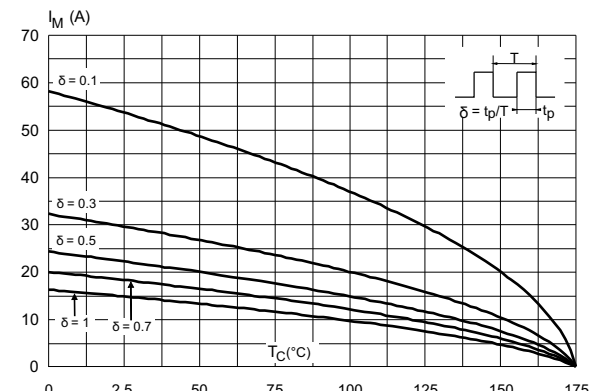

Figure 5. Junction capacitance versus reverse voltage applied (typical values, per diode)

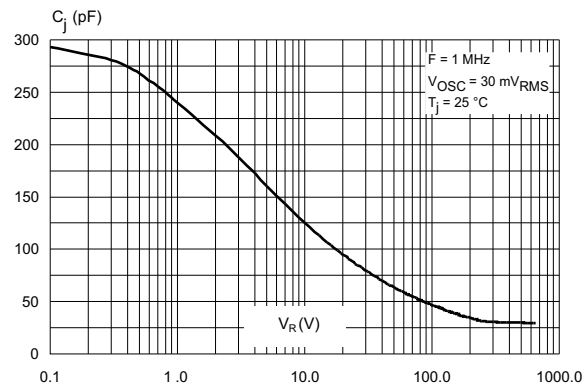

Figure 6. Relative variation of thermal impedance junction to case versus pulse duration

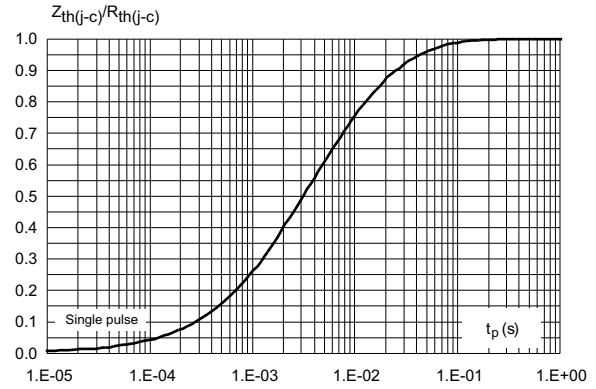

Figure 7. Non-respective peak surge forward current versus pulse duration (sinusoidal waveform, per diode)

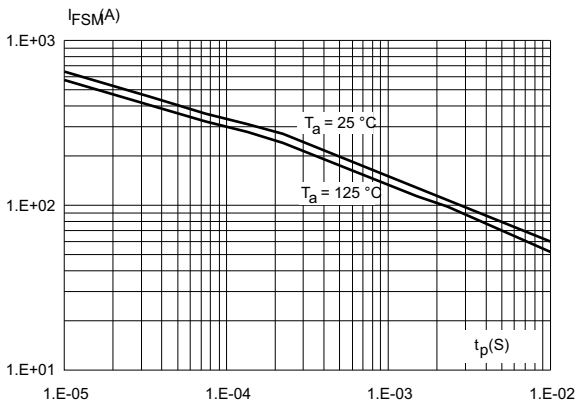
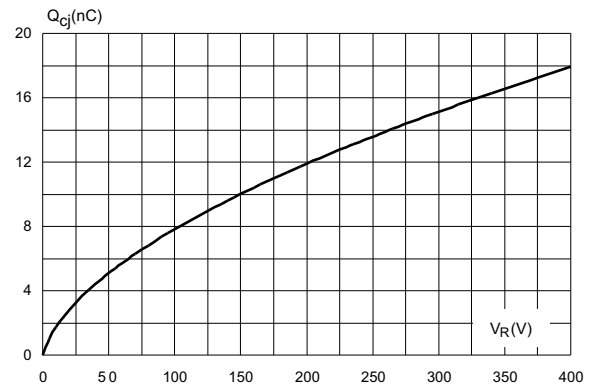

Figure 8. Total capacitive charges versus reverse voltage applied (typical values, per diode)



2 Package information

- Epoxy meets UL94, V0
- Cooling method: conduction (C)
- Recommended torque value: 0.4 to 0.6 N·m

In order to meet environmental requirements, ST offers these devices in different grades of ECOPACK[®] packages, depending on their level of environmental compliance. ECOPACK[®] specifications, grade definitions and product status are available at: www.st.com. ECOPACK[®] is an ST trademark.

2.1 TO-220AB package information

Figure 9. TO-220AB package outline

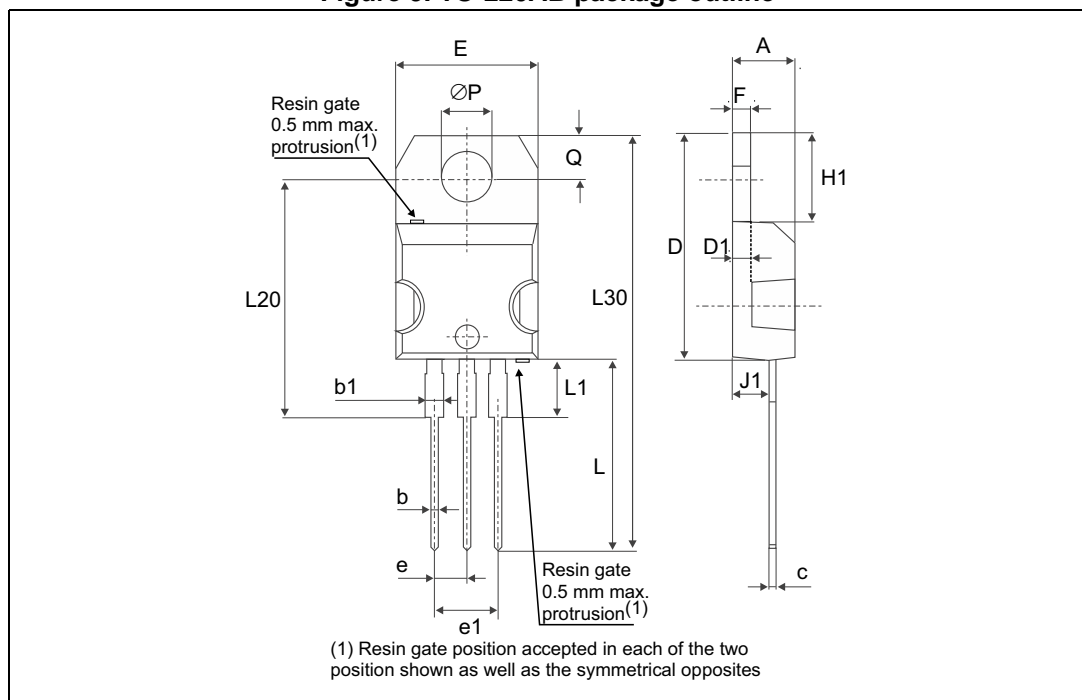

Table 6. TO-220AB package mechanical data

Ref.	Dimensions					
	Millimeters			Inches ⁽¹⁾		
	Typ.	Min.	Max.	Typ.	Min.	Max.
A		4.40	4.60		0.17	0.18
b		0.61	0.88		0.024	0.035
b1		1.14	1.70		0.045	0.067
c		0.48	0.70		0.019	0.027
D		15.25	15.75		0.60	0.62
D1	1.27			0.05		
E		10	10.40		0.39	0.41
e		2.40	2.70		0.094	0.106
e1		4.95	5.15		0.19	0.20
F		1.23	1.32		0.048	0.052
H1		6.20	6.60		0.24	0.26
J1		2.40	2.72		0.094	0.107
L		13	14		0.51	0.55
L1		3.50	3.93		0.137	0.154
L20	16.40			0.64		
L30	28.90			1.13		
∅P		3.75	3.85		0.147	0.151
Q		2.65	2.95		0.104	0.116

1. Values in inches are converted from mm and rounded to 4 decimal digits.

3 Ordering information

Table 7. Ordering information

Order code	Marking	Package	Weight	Base qty	Delivery mode
STPSC12H065CT	PSC12H065CT	TO-220AB	1.86 g	50	Tube

4 Revision history

Table 8. Document revision history

Date	Revision	Changes
24-Jun-2013	1	First issue.
07-Nov-2013	2	Updated Figure 1 and Figure 2.
10-Dec-2015	3	Updated cover page and Table 7 . Format updated to current standard.

IMPORTANT NOTICE – PLEASE READ CAREFULLY

STMicroelectronics NV and its subsidiaries ("ST") reserve the right to make changes, corrections, enhancements, modifications, and improvements to ST products and/or to this document at any time without notice. Purchasers should obtain the latest relevant information on ST products before placing orders. ST products are sold pursuant to ST's terms and conditions of sale in place at the time of order acknowledgement.

Purchasers are solely responsible for the choice, selection, and use of ST products and ST assumes no liability for application assistance or the design of Purchasers' products.

No license, express or implied, to any intellectual property right is granted by ST herein.

Resale of ST products with provisions different from the information set forth herein shall void any warranty granted by ST for such product.

ST and the ST logo are trademarks of ST. All other product or service names are the property of their respective owners.

Information in this document supersedes and replaces information previously supplied in any prior versions of this document.

© 2015 STMicroelectronics – All rights reserved