

Data Sheet

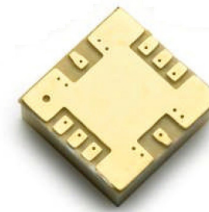

Description

Avago Technologies' AMMP-6233 is a high gain, low-noise amplifier that operates from 18 GHz to 32 GHz. It has a 3 dB noise figure, over 20 dB of gain and designed to be an easy-to-use drop-in with any surface mount PCB application. Popular applications include microwave radios, 802.16 and satellite VSAT or DBS receivers. The fully integrated microwave circuit eliminated the complex tuning and assembly processes typically required by hybrid (discrete-FET) amplifiers. The surface mount package allows elimination of "chip & wire" assembly for lower cost. The device has 50 Ω input and output match and is unconditionally stable. The MMIC has fully integrated input and output DC blocking capacitors and bias choke. The backside of the package is both RF and DC ground that simplifies the assembly process. It is fabricated in a PHEMT process to provide exceptional low noise and gain performance.

Package Diagram

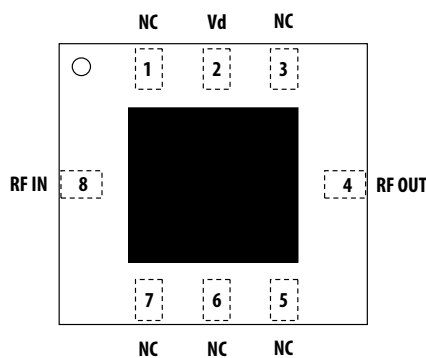

Features

- Surface Mount Package, 5.0 x 5.0 x 1.25 mm
- Integrated DC block and choke
- 50 Ω Input and Output Match
- Single Positive Supply Pin
- No Negative Gate Bias

Specifications (Vd=3.0V, Idd=65mA)

- Broadband RF from 18 to 32 GHz
- High Gain of 23dB
- Low Gain Flatness: ± 1 dB
- Typical Noise Figure of 2.6 dB
- Typical OIP3 of 19dBm

Applications

- Microwave Radio systems
- Satellite VSAT, DBS Up/Down Link
- LMDS & Pt-Pt mmW Long Haul
- Broadband Wireless Access (including 802.16 and 802.20 WiMax)
- WLL and MMDS loops

Functional Block Diagram

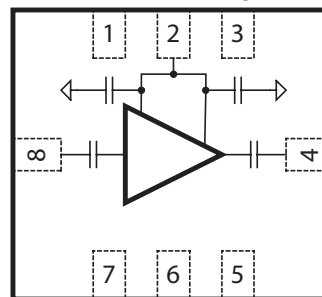

Pin	Function
1	
2	Vdd
3	
4	RFout
5	
6	
7	
8	RFin



Attention: Observe precautions for handling electrostatic sensitive devices.

ESD Machine Model (Class A) = 50V
ESD Human Body Model (Class 0) = 200V
Refer to Avago Application Note A004R:
Electrostatic Discharge, Damage and Control.

Electrical Specifications

1. Small/Large -signal data measured in a fully de-embedded test fixture form TA = 25°C.
2. Pre-assembly into package performance verified 100% on-wafer per AMMC-6220 published specifications.
3. This final package part performance is verified by a functional test correlated to actual performance at one or more frequencies.
4. Specifications are derived from measurements in a 50 Ω test environment. Aspects of the amplifier performance may be improved over a more narrow bandwidth by application of additional conjugate, linearity, or low noise (Γopt) matching.
5. All tested parameters guaranteed with measurement accuracy +/-0.5 dB/ dBm for the 6 to 20 GHz, +/-0.75 dB/ dBm for the 20 to 33 GHz range and +/- 1.0dB/ dBm for the 33 to 50 GHz range
6. NF is measure on-wafer. Additional bond wires (-0.2nH) at Input could improve NF at some frequencies.

Table 1. RF Electrical Characteristics

TA=25°C, Vdd=3.0V, Idd=65mA, Zin=Zo=50 Ω

Parameter	18GHz			26GHz			29GHz			Unit
	Min	Typ	Max	Min	Typ	Max	Min	Typ	Max	
Small Signal Gain, Gain	19	23.2		20.8	24.4		20	23.6		dB
Noise Figure into 50 Ω, NF		2.6	3.6		2.2	3.2		2.6	3.5	dB
Output Power at 1dB Gain Compression, P1dB	8	dBm								
Output Third Order Intercept Point, OIP3	18	dBm								
Isolation, Iso	-45	dB								
Input Return Loss, Rlin	-10	dB								
Output Return Loss, RLout	-13	dB								

Table 2. Recommended Operating Range

1. Ambient operational temperature TA = 25°C unless otherwise noted.
2. Channel-to-backside Thermal Resistance (Tchannel (Tc) = 34°C) as measured using infrared microscopy. Thermal Resistance at backside temperature (Tb) = 25°C calculated from measured data.

Description	Min.	Typical	Max.	Unit	Comments
Drain Supply Current, Id	40	65	90	mA	Vd = 3 V, Under any RF power drive and temperature
Drain Supply Voltage, Vd		3	5	V	

Table 3. Thermal Properties

Parameter	Test Conditions	Value
Thermal Resistance, θch-b	Channel-to-backside Thermal Resistance Tchannel(Tc)=34°C Thermal Resistance at backside temperature Tb=25°C	θch-b = 27 °C/W

Absolute Minimum and Maximum Ratings

Table 4. Minimum and Maximum Ratings

Description	Min.	Max.	Unit	Comments
Drain to Ground Supply Voltage, Vd		5.5	V	
Drain Current, Id		100	mA	
RF CW Input Power		10	dBm	CW
Channel Temperature		+150	°C	
Storage Temperature	-65	+150	°C	
Maximum Assembly Temperature		260	°C	20 second maximum

Note 1. Operation in excess of any one of these conditions may result in permanent damage to this device.

AMMP-6233 Typical Performance [1], [2]

(TA = 25°C, Vdd=3V, Idd=65mA, Zin = Zout = 50 Ω unless noted)

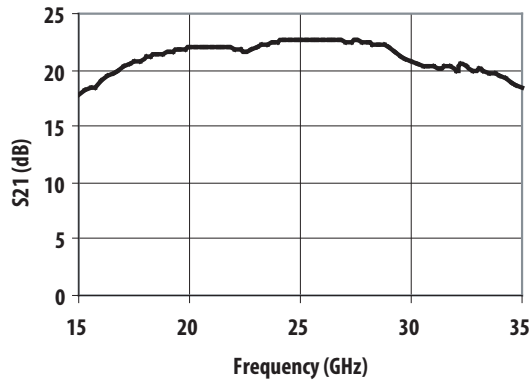

Figure 1. Gain

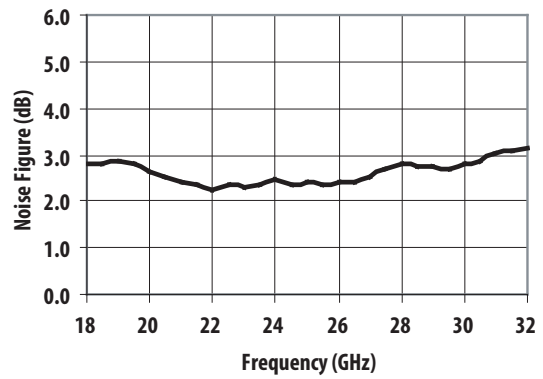

Figure 2. Noise Figure

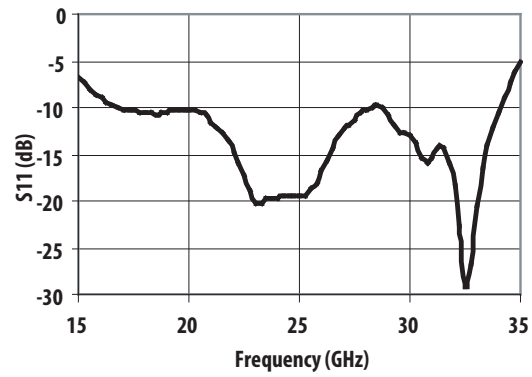

Figure 3. Input Return Loss

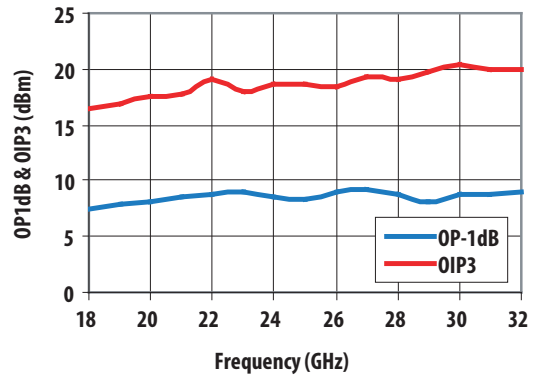

Figure 4. Output P-1dB and Output IP3

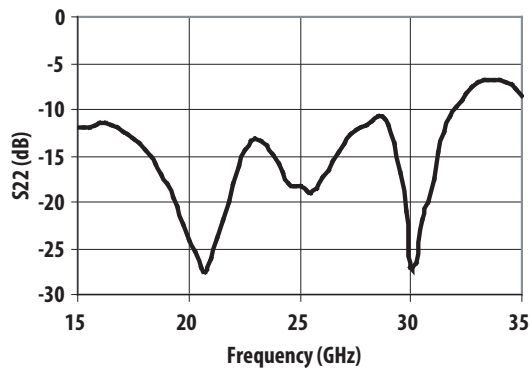

Figure 5. Output Return Loss

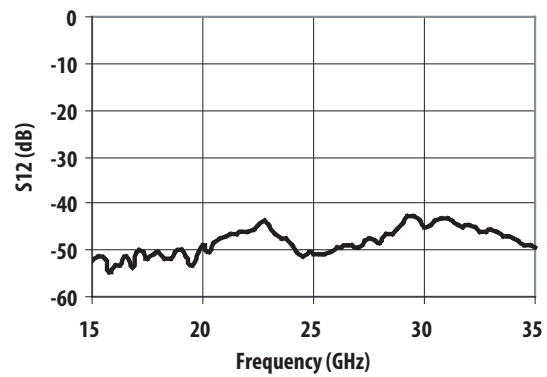

Figure 6. Isolation

AMMP-6233 Typical Performance (cont) [1], [2]

(TA = 25°C, Vdd=3V, Idd=65mA, Zin = Zout = 50 Ω unless noted)

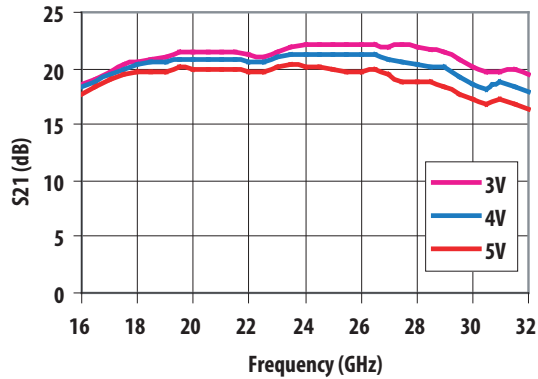

Figure 7. Gain over Vdd

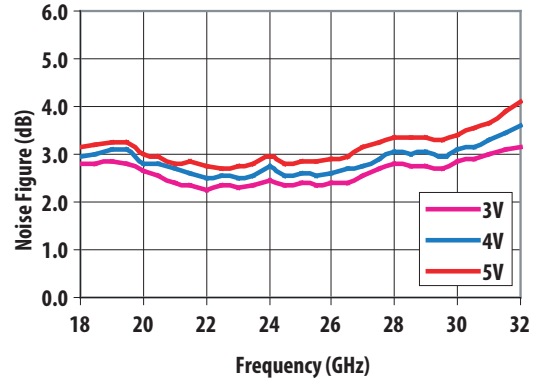

Figure 8. Noise Figure over Vdd

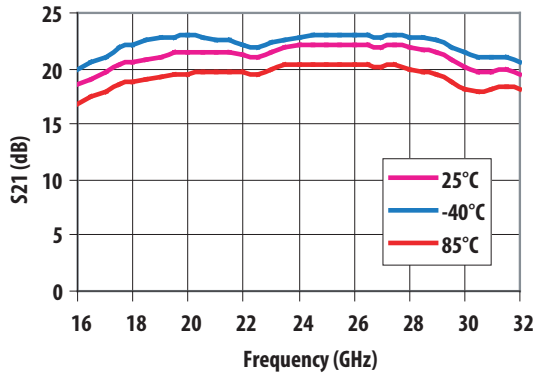

Figure 9. Gain over Temperature

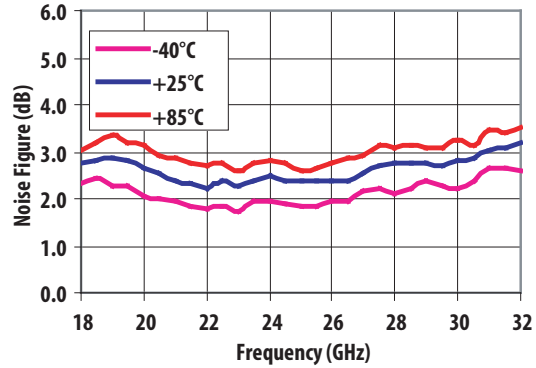

Figure 10. Noise Figure over Temperature

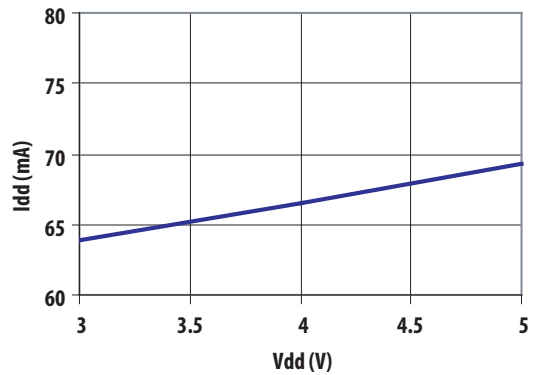

Figure 11. Idd over Vdd

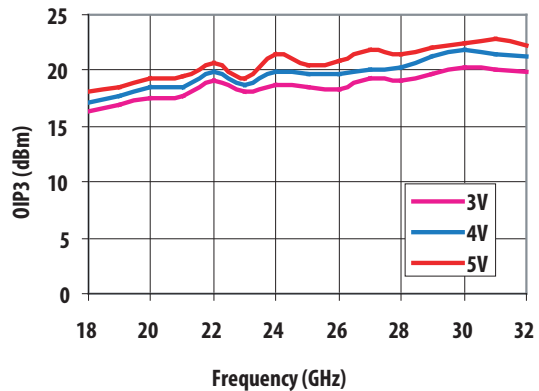
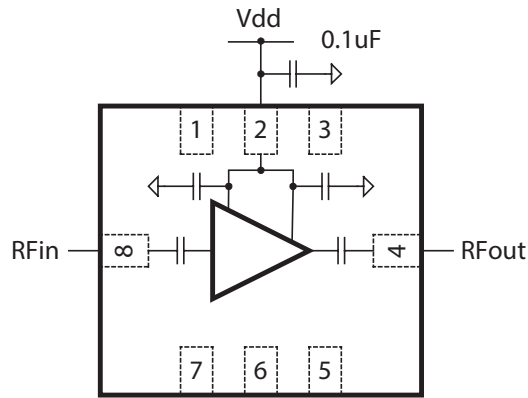

Figure 12. Output IP3 over Vdd

Note:

1. S-parameters are taken with the Evaluation Board as shown in Figure 14. Effects of board and connector are included in the graphs. Loss of board and connector are de-embedded from Gain data.
2. Noise Figure is measured with a 3-dB pad at the input of the device. Losses are de-embedded from the data shown in Figure 2, 8 and 10.

AMMP-6233 Application and Usage



AMMP-6233

Figure 13. Application of AMMP-6233

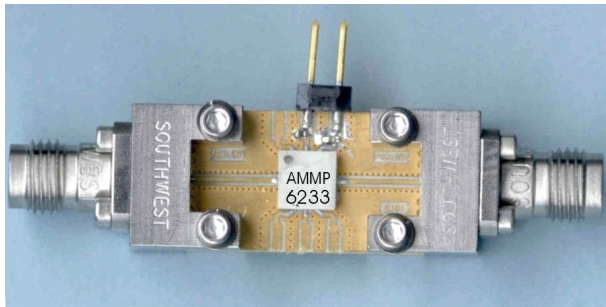

Figure 14. Evaluation / Test Board (Available to qualified customer requests)

Biasing and Operation

The AMMP-6233 is normally biased with a positive drain supply connected to the VDD pin through a 0.1uF bypass capacitor as shown in Figure 13. The recommended drain supply voltage is 3V. It is important to have 0.1uF bypass capacitor, and the capacitor should be placed as close to the component as possible. Input and output ports are DC-blocked. Impedance matching at input and output ports are achieved on-chip, therefore, no extra external component is needed. Aspects of the amplifier performance may be improved over a narrower bandwidth by application of additional conjugate, linearity, or low noise (Γ_{opt}) matching. No ground wires are needed because all ground connections are made with plated through-holes to the backside of the package.

Refer the Absolute Maximum Ratings table for allowed DC and thermal condition

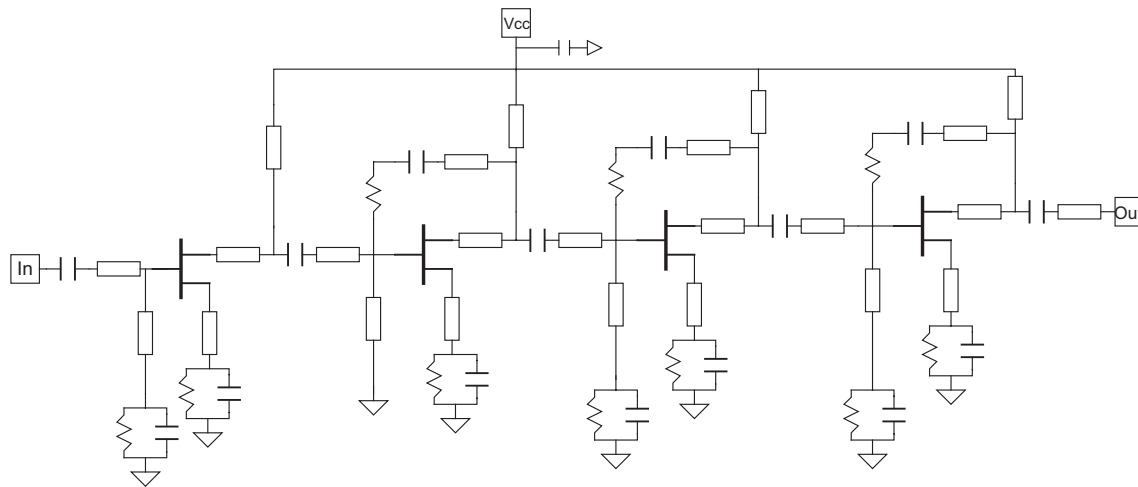

Figure 15. Simplified LNA Schematic

Typical Scattering Parameters

Please refer to <<http://www.avagotech.com>> for typical scattering parameters data.

Package Dimension, PCB Layout and Tape and Reel information

Please refer to Avago Technologies Application Note 5520, AMxP-xxxx production Assembly Process (Land Pattern A).

AMMP-6233 Part Number Ordering Information

Part Number	Devices Per Container	Container
AMMP-6233-BLKG	10	Antistatic bag
AMMP-6233-TR1G	100	7" Reel
AMMP-6233-TR2G	500	7" Reel

For product information and a complete list of distributors, please go to our web site: www.avagotech.com

Avago, Avago Technologies, and the A logo are trademarks of Avago Technologies in the United States and other countries. Data subject to change. Copyright © 2005-2013 Avago Technologies. All rights reserved. Obsoletes AV01-0666EN AV02-0489EN - July 8, 2013

