



AK6416A

16Kbit Serial CMOS EEPROM

Features

- ADVANCED CMOS EEPROM TECHNOLOGY
- READ/WRITE NON-VOLATILE MEMORY
 - Wide Vcc (1.8V ~ 5.5V) operation
 - 16384 bits: 1024 × 16 organization
- ONE CHIP MICROCOMPUTER INTERFACE
 - Interface with one chip microcomputer's serial communication port directly
- LOW POWER CONSUMPTION
 - 0.8μA Max (Standby mode)
- HIGH RELIABILITY
 - Endurance : 100K cycles
 - Data Retention : 10 years
- SPECIAL FEATURES
 - High speed operation (f_{MAX}=4MHz: Vcc=4.5V ~ 5.5V)
 - Automatic write cycle time-out with auto-ERASE
 - Automatic address increment (READ)
 - Ready/Busy status signal
 - Software and Hardware controlled write protection
- IDEAL FOR LOW DENSITY DATA STORAGE
 - Low cost, space saving, 8-pin package (SSOP)

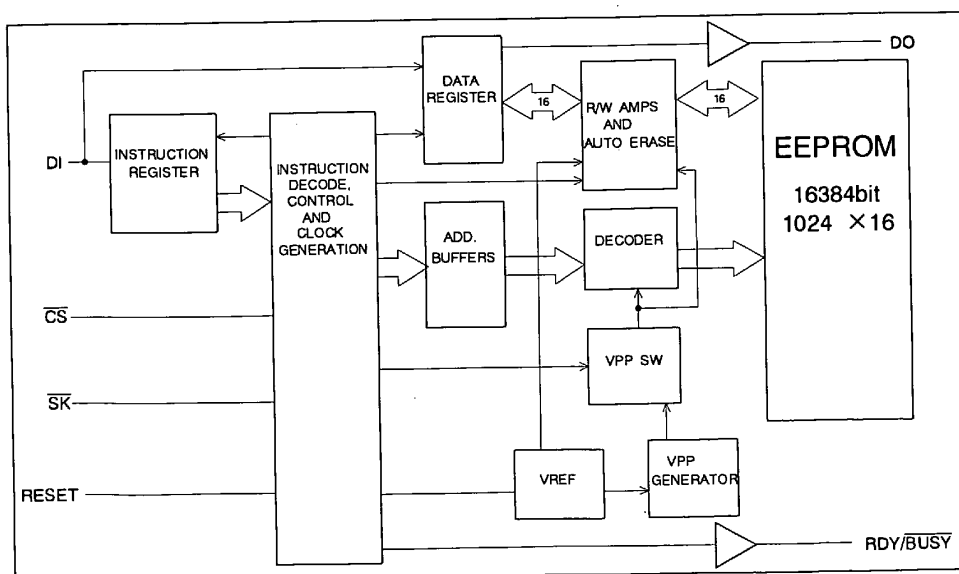

Block diagram

General Description

The AK6416A is a 16384bit, serial, read/write, non-volatile memory device fabricated using an advanced CMOS EEPROM technology. The AK6416A has 16384bits of memory organized into 1024 registers of 16 bits each. The AK6416A can operate full function under wide operating voltage range from 1.8V to 5.5V. The charge up circuit is integrated for high voltage generation that is used for write operation.

The AK6416A can connect to the serial communication port of popular one chip microcomputer directly (3 line negative clock synchronous interface). At write operation, AK6416A takes in the write data from data input pin (DI) to a register synchronously with rising edge of input pulse of serial clock pin (\overline{SK}). And at read operation, AK6416A takes out the read data from a register to data output pin (DO) synchronously with falling edge of \overline{SK} .

The AK6416A has 4 instructions such as READ, WRITE, WREN (write enable) and WRDS (write disable). Each instruction is organized by op-code block (8bits), address block (8bits) and data (8bits \times 2). When input level of \overline{SK} pin is high level and input level of chip select (\overline{CS}) pin is changed from high level to low level, AK6416A can receive the instructions.

Special features of the AK6416A include : automatic write time-out with auto-ERASE, Ready/ \overline{Busy} status signal output and ultra-low standby power mode when deselected (\overline{CS} =high).

- Software and Hardware controlled write protection

The AK6416A has 2 (hardware and software) write protection functions.

After power on or after execution of WRDS (write disable) instruction, execution of WRITE instruction will be disabled. This write protection condition continues until WREN instruction is executed or Vcc is removed from the part.

Execution of READ instruction is independent of both WREN and WRDS instructions.

Reset pin should be low level when WRITE instruction is executed. When the Reset pin is high level, the WRITE instruction is not executed.

- Ready/ \overline{Busy} status signal

During the automatic write time-out period (\overline{BUSY} status), the AK6416A can't accept the other instructions.

The AK6416A has 2 functions to know the \overline{Busy} status from exterior.

The RDY/ \overline{BUSY} pin indicates the \overline{Busy} status regardless of the \overline{CS} pin status. The RDY/ \overline{BUSY} pin outputs the low level regardless of the \overline{CS} pin status during \overline{Busy} status. Except the above status, this pin outputs high level.

Also the DO pin indicates the \overline{Busy} status. When input level of \overline{SK} pin is low level and input level of \overline{CS} pin is changed from high level to low level, the AK6416A is in the status output mode and the DO pin indicates the Ready/ \overline{Busy} status. The Ready/ \overline{Busy} status outputs on DO pin until \overline{CS} pin is changed from low level to high level, or first bit ("1") of op-code of next instruction is given to the part. Except when the device is in the status output mode or outputs data, the DO pin is in the high impedance state.

■ Type of Products

Model	Memory size	Temp.Range	Vcc	Package
AK6416AM	16Kbits	-40°C~85°C	1.8V~5.5V	8pin Plastic SSOP

Pin arrangement

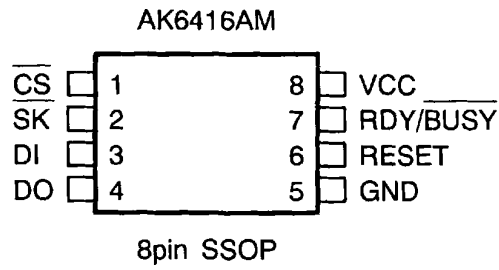

■ Pin Function

Pin No.	Pin name	I/O
1	\overline{CS}	I
2	\overline{SK}	I
3	DI	I
4	DO	O
5	GND	
6	RESET	I
7	$\overline{RDY/BUSY}$	O
8	Vcc	

Note

- I : Input pin
- O : Output pin

■ Pin Description

\overline{CS} (Chip Select)

When \overline{SK} is high level and \overline{CS} is changed from high level to low level, AK6416A can receive the instructions. \overline{CS} should be kept low level while receiving op-code, address and data and while outputting data. If \overline{CS} is changed to high level during the above period, AK6416A stops the instruction execution. When \overline{SK} is low and \overline{CS} is changed from high level to low level, AK6416A will be in status output mode. The \overline{CS} need not be low level during the automatic write time-out period (\overline{BUSY} status).

\overline{SK} (Serial Clock)

The \overline{SK} clock pin is the synchronous clock input for input/output data. At write operation, AK6416A takes in the write data from data input pin (DI) synchronously with rising edge of input pulse of serial clock pin (\overline{SK}). And at read operation, AK6416A takes out the read data to data output pin (DO) synchronously with falling edge of \overline{SK} . The \overline{SK} clock is not needed during the automatic write time-out period (\overline{BUSY} status), the status output period and when the device isn't selected (\overline{CS} = high level).

DI (Data Input)

The op-code, address and write data is input to the DI pin.

DO (Data Output)

The DO pin outputs the read data and status signal and will be high impedance except for this timing.

RDY/ \overline{BUSY} (Ready/Busy status)

This pin outputs the internal programming status. When the AK6416A is in the automatic write time-out period, this pin outputs the low level (\overline{BUSY} status), and outputs the high level except for this timing.

RESET (Reset)

The AK6416A stops executing the write instruction when the RESET pin is high level. The RESET pin should be low level while the write instruction input period and the automatic write time-out period. If the RESET pin is high level while the automatic write time-out period, the AK6416A stops execution of internal programming and the device returns to ready status. In this case the word data of the specified address will be incomplete. When inputting the new instruction after RESET, the \overline{CS} pin should be set to high level. The read, write enable and write disable instructions are not affected by RESET pin status.

Vcc (Power Supply)

GND (Ground)

Functional Description

The AK6416A has 4 instructions such as READ, WRITE, WREN (write enable) and WRDS (write disable). Each instruction is organized by op-code block (8bits), address block (8bits) and data (8bits × 2). When input level of \overline{SK} pin is high level and input level of chip select (\overline{CS}) pin is changed from high level to low level, AK6416A can receive the instructions.

When the instructions are executed consecutively, the \overline{CS} pin should be brought to high level for a minimum of 250ns(T_{cs}) between consecutive instruction cycle.

□ **Instruction Set For 6416A**

Instruction	Op-Code	Address	Data
WRITE	1 0 1 0 0 1 A9 A8	A7 A6 A5 A4 A3 A2 A1 A0	D15 -D0
READ	1 0 1 0 1 0 A9 A8	A7 A6 A5 A4 A3 A2 A1 A0	D15 -D0
WREN	1 0 1 0 0 0 1 1	× × × × × × × ×	
WRDS	1 0 1 0 0 0 0 0	× × × × × × × ×	
(WRAL)	1 0 1 0 1 1 1 1	× × × × × × × ×	D15 -D0

×:don't care

(Note) The WRAL instruction is used for factory function test only. User can't use this instruction .

Write

The write instruction is followed by 16 bits of data to be written into the specified address. After the 32nd rising edge of \overline{SK} to read D0 in, the AK6416A will be put into the automatic write time-out period. During the automatic write time-out period (\overline{Busy} status)and while entering write instruction, the RESET pin should be low level. If the RESET pin is set to high level during the automatic write time-out period, the AK6416A stops execution of internal programming and the device returns to ready status. In this case the word data of the specified address will be incomplete. When inputting the new instructoin after RESET, the \overline{CS} pin should be set to high level. When inputting the new instruction after RESET, the \overline{CS} pin should be set to high level. When the RESET pin is kept at high level, the write is not executed. This becomes write protection function. The \overline{CS} pin need not be high level during automatic write time-out period (\overline{BUSY} status).

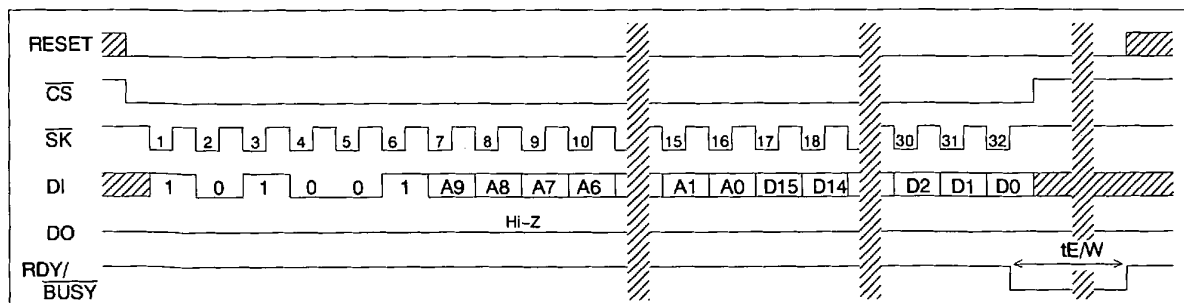

WRITE

Read

The read instruction is the only instruction which outputs serial data on the DO pin. When the 17th falling edge of \overline{SK} is received, the DO pin will come out of high impedance state and shift out the data from D15 first in descending order which is located at the address specified in the instruction.

The data in the next address can be read sequentially by continuing to provide clock. The address automatically cycles to the next higher address after the 16bit data shifted out. When the highest address is reached (\$3FF), the address counter rolls over to address \$000 allowing the read cycle to be continued indefinitely.

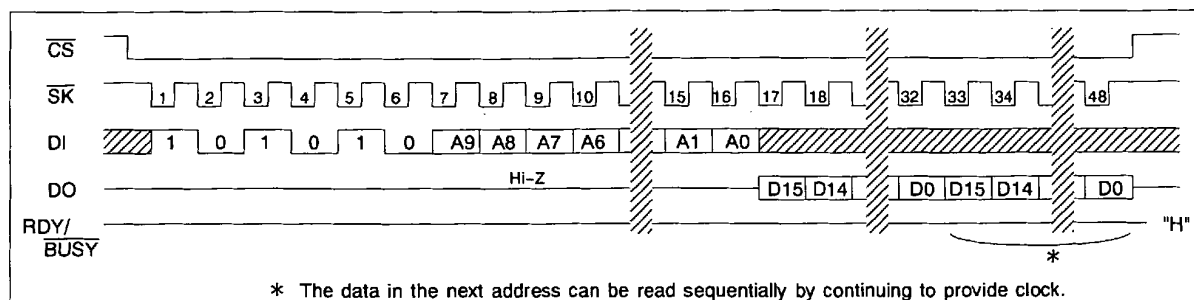

READ

WREN / WRDS (Write Enable and Write Disable)

When Vcc is applied to the part, it powers up in the programming disable (WRDS) state. Programming must be preceded by a programming enable (WREN) instruction. Programming remains enabled until a programming disable (WRDS) instruction is executed or Vcc is removed from the part. The programming disable instruction is provided to protect against accidental data disturb. Execution of a read instruction is not affected by both WREN and WRDS instructions.

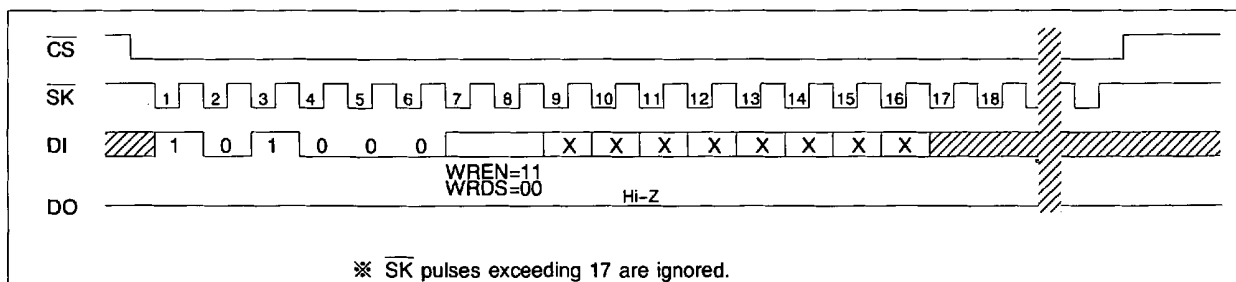

WREN/WRDS

Absolute Maximum Ratings

Parameter	Symbol	Min	Max	Unit
Power Supply	VCC	-0.6	+7.0	V
All Input Voltages with Respect to Ground	VIO	-0.6	VCC+0.6	V
Ambient storage temperature	Tst	-65	+150	°C

Stress above those listed under "Absolute Maximum Ratings" may cause permanent damage to the device. This is a stress rating only and functional operation of the device at these or any other conditions above those indicated in the operational sections of the specification is not implied. Exposure to absolute maximum conditions for extended periods may affect device reliability.

Recommended Operating Condition

Parameter	Symbol	Min	Max	Unit
Power Supply	VCC	1.8	5.5	V
Ambient Operating Temperature	Ta	-40	+85	°C

Electrical Characteristics

(1) D.C. ELECTRICAL CHARACTERISTICS

(1.8V≤Vcc≤5.5V, -40°C≤Ta≤85°C, unless otherwise specified)

Parameter	Symbol	Condition	Min.	Max.	Unit
Current Dissipation (WRITE)	ICC1	VCC=5.5V, tSKP=250ns, *1		5.5	mA
	ICC2	VCC=2.5V, tSKP=500ns, *1		3.5	mA
	ICC3	VCC=1.8V, tSKP=1.0us, *1		2.5	mA
Current Dissipation (READ,WREN, WRDS)	ICC4	VCC=5.5V, tSKP=250ns, *1		1.5	mA
	ICC5	VCC=2.5V, tSKP=500ns, *1		0.3	mA
	ICC6	VCC=1.8V, tSKP=1.0us, *1		0.2	mA
Current Dissipation (Standby)	ICCSB	VCC=5.5V *2		0.8	uA
Input High Voltage1 CS, SK, RESET pin	VIH1	1.8V≤VCC≤5.5V	0.8 × VCC	VCC+0.5	V
Input High Voltage2 DI pin	VIH2	2.5V≤VCC≤5.5V	0.7 × VCC	VCC+0.5	V
	VIH3	1.8V≤VCC<2.5V	0.8 × VCC	VCC+0.5	V
Input Low Voltage1 CS, SK, RESET pin	VIL1	1.8V≤VCC≤5.5V	0	0.2 × VCC	V
Input Low Voltage2 DI pin	VIL2	2.5V≤VCC≤5.5V	0	0.3 × VCC	V
	VIL3	1.8V≤VCC<2.5V	0	0.2 × VCC	V
Output High Voltage	VOH1	2.5V≤VCC≤5.5V IOH=-50μA	VCC-0.3		V
	VOH2	1.8V≤VCC<2.5V IOH=-50μA	VCC-0.3		V
Output Low Voltage	VOL1	2.5V≤VCC≤5.5V IOL=1.0mA		0.4	V
	VOL2	1.8V≤VCC<2.5V IOL=0.1mA		0.4	V
Input Leakage	ILI	VCC=5.5V, VIN=5.5V		±1.0	uA
Output Leakage	ILO	VCC=5.5V VOUT=5.5V, CS=VCC		±1.0	uA

*1: VIN=VIH/VIL, DO=RDY/BUSY=Open

*2: CS=Vcc, SK/DI/RESET=Vcc/GND, DO=RDY/BUSY=Open

(2) A.C. ELECTRICAL CHARACTERISTICS

(1.8V≤VCC≤5.5V, -40°C≤Ta≤85°C, unless otherwise specified)

Parameter	Symbol	Condition	Min.	Max.	Unit
$\overline{\text{SK}}$ Cycle Time	tSKP1	4.5V≤VCC≤5.5V	250		ns
	tSKP2	2.5V≤VCC<4.5V	500		ns
	tSKP3	1.8V≤VCC<2.5V	1.0		us
$\overline{\text{SK}}$ Pulse Width	tSKW1	4.5V≤VCC≤5.5V	125		ns
	tSKW2	2.5V≤VCC<4.5V	250		ns
	tSKW2	1.8V≤VCC<2.5V	500		ns
$\overline{\text{CS}}$ Setup Time	tCSS1	4.5V≤VCC≤5.5V	50		ns
	tCSS2	1.8V≤VCC<4.5V	100		ns
$\overline{\text{CS}}$ Hold Time	tCSH1	4.5V≤VCC≤5.5V	50		ns
	tCSH2	1.8V≤VCC<4.5V	100		ns
$\overline{\text{SK}}$ Setup Time	tSKSH/L1	4.5V≤VCC≤5.5V	50		ns
	tSKSH/L2	1.8V≤VCC<4.5V	100		ns
RESET Setup Time	tRESS		0		ns
RESET Hold Time	tRESH		0		ns
Data Setup Time	tDIS1	4.5V≤VCC≤5.5V	50		ns
	tDIS2	2.5V≤VCC<4.5V	100		ns
	tDIS3	1.8V≤VCC<2.5V	200		ns
Data Hold Time	tDIH1	4.5V≤VCC≤5.5V	50		ns
	tDIH2	2.5V≤VCC<4.5V	100		ns
	tDIH3	1.8V≤VCC<2.5V	200		ns
DO pin Output delay	tPD1	4.5V≤VCC≤5.5V, *3		75	ns
	tPD2	2.5V≤VCC<4.5V, *3		150	ns
	tPD3	1.8V≤VCC<2.5V, *3		300	ns
RDY/ $\overline{\text{BUSY}}$ pin Output delay	tPD	CL=100pF		1	us
Selftimed Programming Time	tE/W1	2.5V≤VCC≤5.5V		7	ms
	tE/W2	1.8V≤VCC<2.5V		10	ms
Write Recovery Time	tRC		100		ns
Min $\overline{\text{CS}}$ High Time	tCS		250		ns
DO High-Z Time	tOZ			500	ns

*3:CL=100pF

Synchronous Data Timing

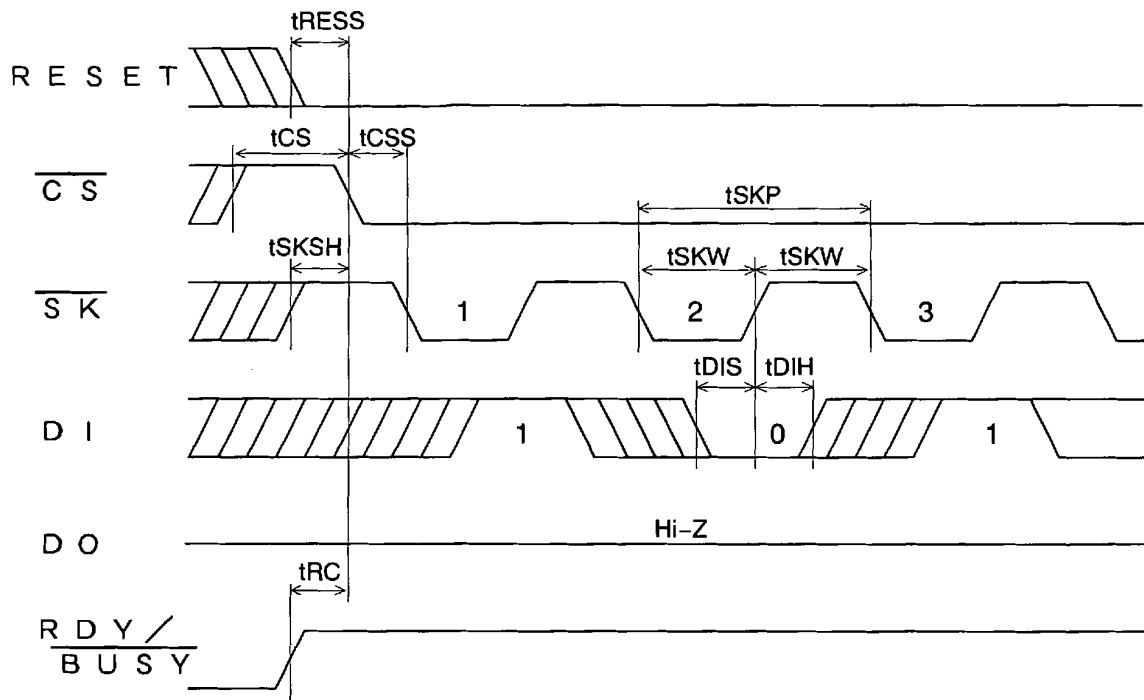

Instruction Input

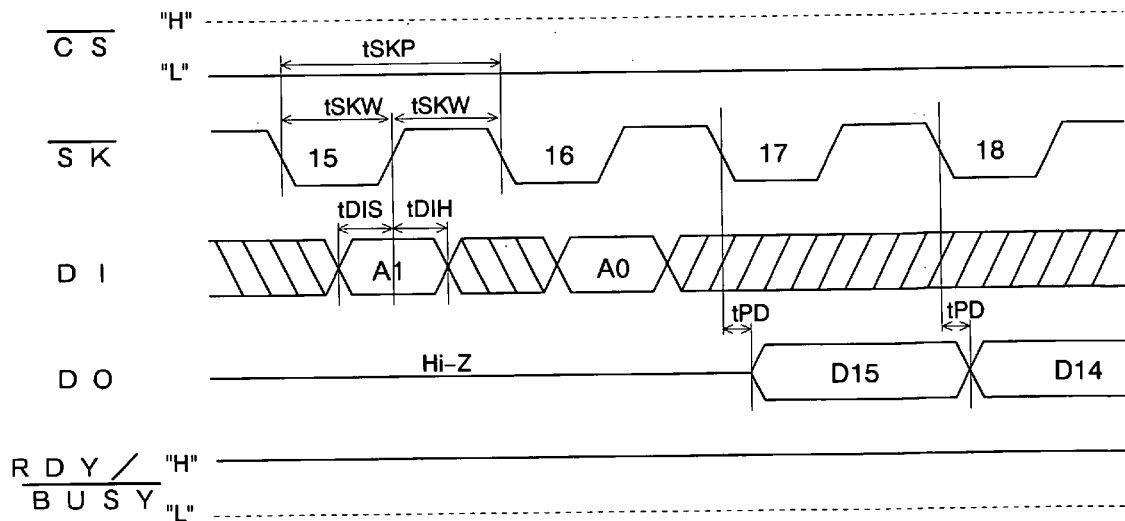

Data Output (READ)

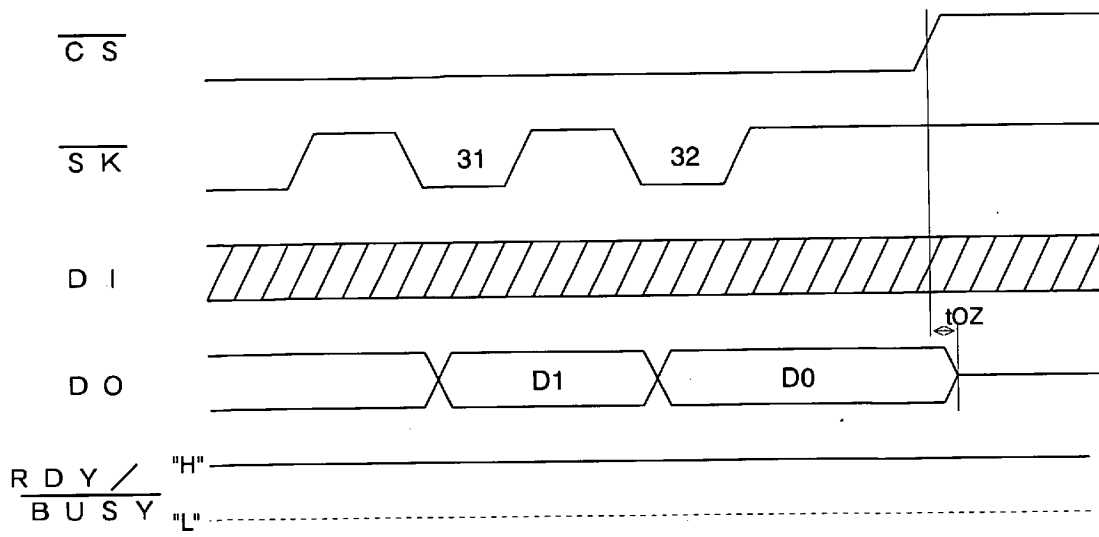

Data Output (READ)

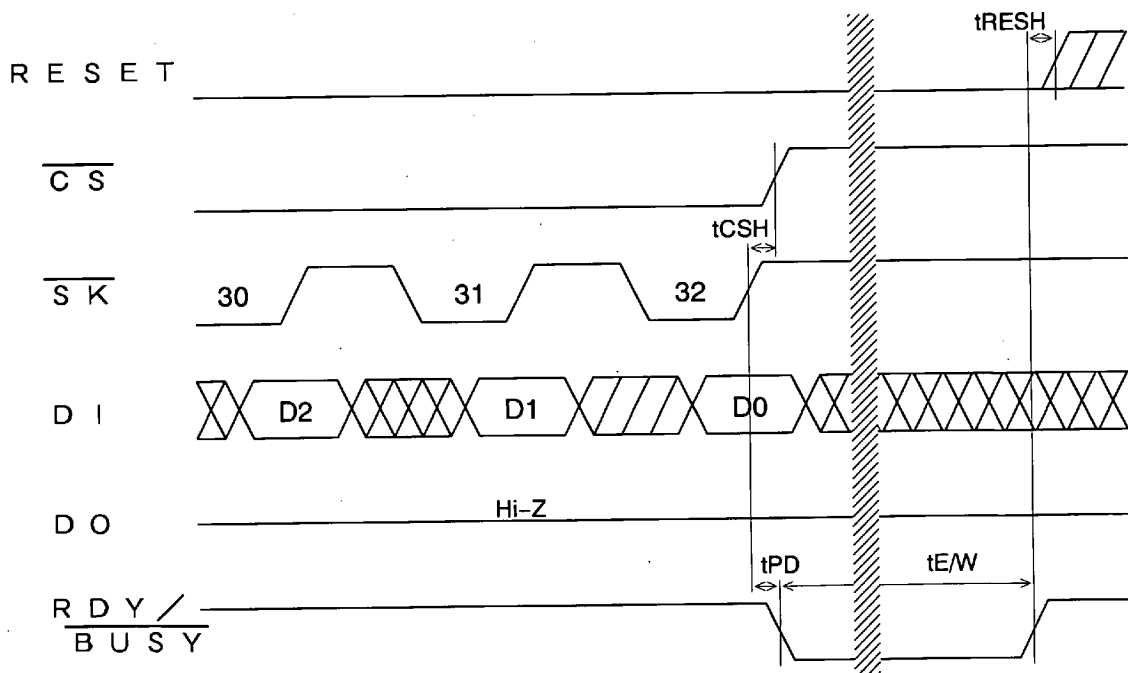

Ready / $\overline{\text{BUSY}}$ Signal Output (RDY/ $\overline{\text{BUSY}}$ pin)

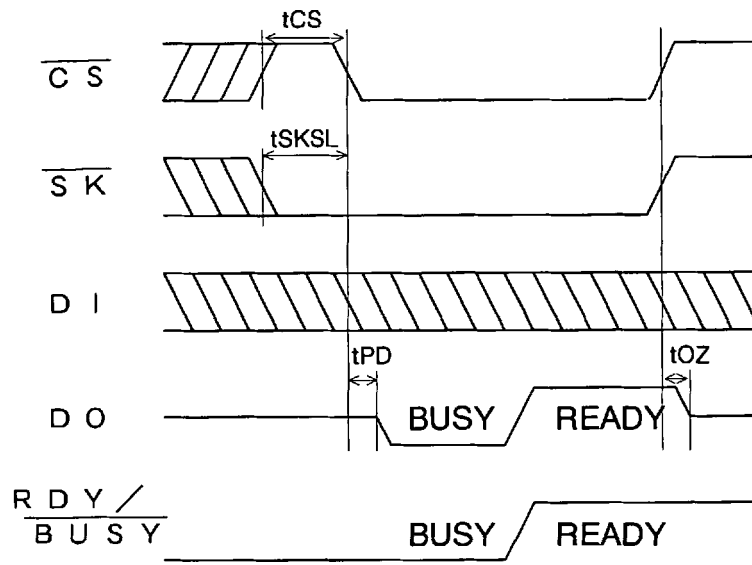

Ready / $\overline{\text{BUSY}}$ Signal Output (DO pin)